

LCD Rack Monitor



PRM-902Q

MULTI-CHANNEL LCD MONITOR

User's Manual



POSTIUM KOREA



Contents

PRM-902Q

Warnings	3
Features	4
Name & Function of Each Part	5
OSD Menu Organization & Adjustment	8
Other Functions	15
System Default Value.....	24
Product Specification	26

Warning

- Always use set voltage.
 - DC 12V
- If liquid is spilled on or impacts this product, please disconnect the product immediately and seek professional help before continued use.
- Keep unit disconnected during extended periods of disuse.
- Keep unit in a well-ventilated place to prevent overheating.
- Do not install the product near any heat-generating equipment.
Also, keep the product out of direct sunlight or dusty areas.
- Only clean the product with a noncommercial, mild and neutral detergent.
- When transporting the product, make use of its original packaging for safer carriage.

FCC (Federal Communications Commission)

This equipment has been tested and found to comply with the limits for class A digital device, pursuant to part 15 of the FCC Rules. These limits are designed to provide reasonable protection against harmful interference when the equipment is operated in a commercial environment.

This equipment generates, uses, and can radiate radio frequency energy, and if not installed and used in accordance with the instruction manual, may cause harmful interference to radio communications. Operation of this equipment in a residential to correct the interference at his own expense

⚠ Warning!! : Change or modifications not expressly approved by the manufacturer responsible for compliance void the user's authority to operate the equipment.

Disposal of Old Electrical & Electronic Equipment (Applicable in the European Union and other European countries with separate collection systems)



This symbol on the product or on its packing indicates that this product shall not be treated as household waste. Instead it shall be handed over to the applicable collection point for the recycling of electrical and electronic equipment. By ensuring this product is disposed of correctly, you will help prevent potential negative consequence for the environment and human health, which could otherwise be caused by inappropriate waste handling of this product. The recycling of materials will help to conserve natural resources.



Features

Multi-Format PRM-902Q Series unit has the following features:

- **Compatible with varied SDI Signals**

The product is compatible with varied SDI signal

- 480i, 576i, 720p, 1035i, 1080i, 1080p, 1080psf, 2K

- **Compatible with varied Analog Signals**

The product is compatible with varied Composite, S-Video signal

- NTSC, PAL, SECAM

The product is compatible with varied Component, RGB signal

- 480i, 576i, 480p, 576p, 720p, 1080i, 1080p

- **Waveform/Vector Scope/Audio Level Meter**

“Y”, “Cb”, “Cr” Waveform & Vector Scope available for SDI Signals

16-CH Embedded Audio Level Meter

- **Audio Out**

Built in Audio De-embedder and Internal Speakers

Stereo Audio out using phone jack

- **Knob Control**

Easy to adjust user configuration using the control knob

- **BLUE & MONO**

- **H/V Delay**

- **Wide Variety of Markers & Safety Areas**

Center Marker, Safety Area Marker, Aspect Marker, Display Size(Scan)

- **Pixel To Pixel**

Provides both full screen and unscaled native image.

- **Wide Screen / LED Backlight**

- **24Bit RGB LVDS Interface Panel**

- **DC Compatible**

The product is powered by normal 12V source.

- **Remote control function**

Simple remote controllability with single cable connection,

no additional modules required

- **Additional Features**

Active Loop Through/SDI, 1000:1 contrast ratio, 400 cd/m² brightness,

OSD user interface, Rack Mountable

Name & Function of Each Part

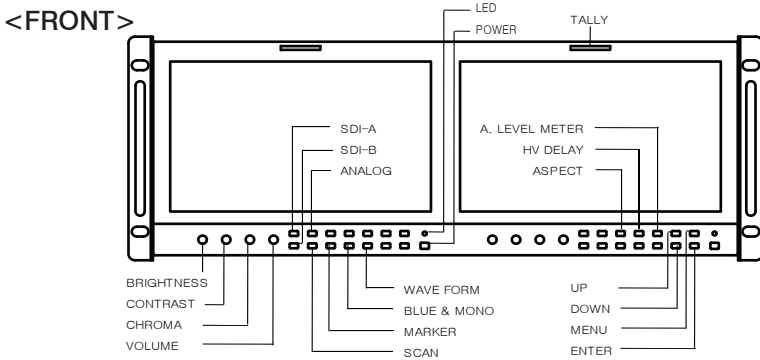

- **[BRIGHT] knob**
Used to adjust the degree of brightness between MAX(25) and MIN(-25).
- **[CONTRAST] knob**
Used to adjust the contrast ration between MAX(25) and MIN(-25).
- **[CHROMA] knob**
Used to adjust the saturation between MAX(25) and MIN(-25).
- **[VOLUME] knob**
Used to adjust the volume between MAX(20) and MIN(0).
- **[SDI-A] button/lamp**
Used to select SDI A Input.
- **[SDI-B] button/lamp**
Used to select SDI B Input.
- **[ANALOG] button/lamp**
Used to select desired Analog Input (CVBS1/2/3, S-Video, Component, RGB).
- **[SCAN] button/lamp**
Used to transfer from OVER SCAN mode to ZERO SCAN mode.
Mode changes in the order of ZERO SCAN -> OVER SCAN -> PIXEL TO PIXEL
-> ZERO SCAN.
#This function is not available in Internal Pattern and Wave Form/Vector Scope full size.



- **[ASPECT] button/lamp**
Used to toggle aspect ratio in SD from standard to anamorphic.
- This function is not available in Internal Pattern and Wave Form/Vector Scope full size.
- **[MARKER] button/lamp**
Used to show MARKER on the screen. The type of marker at work may be selected on the main menu.
- This function is not available in Internal Pattern, Wave Form/Vector Scope full size, Pixel to Pixel and HV Delay mode.
- **[HVDELAY] button/lamp**
Used to activate the HV Delay mode.
- This function is not available in Internal Pattern and Wave Form/Vector Scope full size.
- **[BLUE/MONO] button/lamp**
You may remove R(red) and G(green) from the input signal and play the screen only with B(blue) signal. Button may be pressed twice to change the screen to MONO mode. (This mode uses only Luminance value)
- This function is not available in Internal Pattern and Wave Form/Vector Scope full size.
- **[AUDIO LEVEL] button/lamp**
Used to activate AUDIO LEVEL METER on the screen. The type of audio level meter at work may be selected on the main menu.
- This is available only SDI input.
- **[WAVE/VECTOR] button/lamp**
Used to activate the Waveform or Vector Scope.
Small and Full Waveform/Vector Scope display can be selected in the system menu.
Small display : YCbCr → Y → Cb → Cr → Vector → off
Full display : Y → Cb → Cr → Vector → off
(Use "WAVE/VECTOR" button to control)
- This is available only SDI input.
- **[UP] button**
Used to navigate menu during OSD menu activation. It may also be used to toggle clockwise through 1:1 quadrants in native scan mode.
- **[DOWN] button**
Used to navigate menu during OSD menu activation. It may also be used to toggle counterclockwise through 1:1 quadrants in native scan mode.
- **[MENU] button**
Used to activate the OSD menu.
- **[ENTER] button**
Used to confirm a chosen value (or mode) within the OSD menu.
- This can be used to control the position of Wave/Vector in small size.
- **[POWER] button**
Power On/Off button.
If the signal is normal, LED lights in Green. If the signal is unsupported or disconnected, LED flashes in Yellow.
- **TALLY**
LED indicating monitor's current status using optional Remote.

PRM-902Q MULTI-CHANNEL LCD MONITOR

Name & Function of Each Part

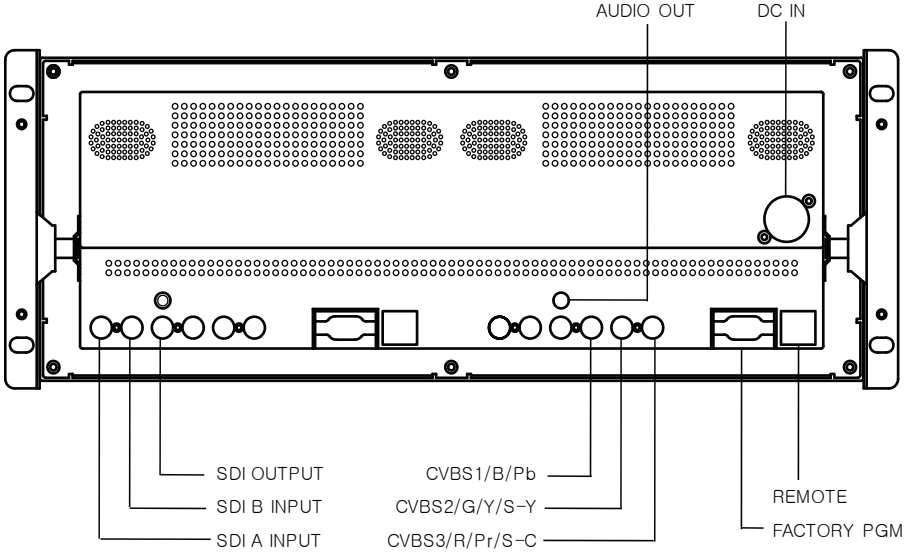

• **SDI A-IN (BNC)**
SDI A signal input terminal

• **SDI B-IN (BNC)**
SDI B signal input terminal

• **SDI-OUT (BNC)**
SDI signal output terminal

• **CVBS1/B/Pb (BNC)**
Signal input terminal used for COMPOSITE1, RGB B, COMPONENT Pb signals.

• **CVBS2/G/Y/S-Y (BNC)**
Signal input terminal used for COMPOSITE2, RGB G, COMPONENT Y, SVIDEO Y signals.

• **CVBS3/R/Pr/S-C (BNC)**
Signal input terminal used for COMPOSITE3, RGB R, COMPONENT Pr, SVIDEO C signals.

• **AUDIO OUT (phone jack)**
Used to audio output jack.

• **FACTORY PGM (15 pins)**
Input connector for FACTORY PGM allowing for firmware updates.

• **REMOTE (RJ-45)**
Connection for remote control of monitor.

• **DC IN (XLR, 4 pins)**
Used to supply DC power; 12V

Connector	Composite	Component	RGB	S-Video
1	CVBS1	Pb	B	No Con.
2	CVBS2	Y	G	Y
3	CVBS3	PR	R	C

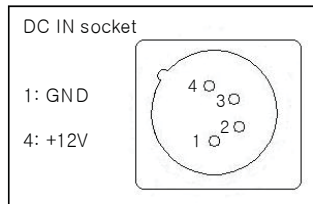



OSD Menu Organization & Adjustment

[1] MAIN - Picture

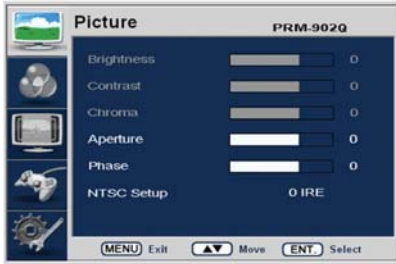

· Brightness

This Item controls the degree of brightness.

#Brightness can be adjusted by using the [BRIGHT] control knob on the front of the monitor.

· Contrast

This item controls the contrast ratio.

#Contrast can be adjusted by using the [CONTRAST] control knob on the front of the monitor.

· Chroma

This item controls saturation.

#Saturation can be adjusted by using the [CHROMA] control knob on the front of the monitor.

· Aperture

This item controls the picture sharpness.

· Phase

This item controls Phase value (Hue).

#This function is only available in Composite and S-Video NTSC Input.

· NTSC Setup

This item sets IRE value in NTSC mode between 0 IRE and 7.5 IRE.

#This function is only available in NTSC Input.

[2] MAIN - Color



· Color Temp

This item controls Color Temperature with presets of 3200K, 5600K, 6500K, 9300K, and User1, User2, User3 mode.

· User

On User Mode, the user may select and control R, G, & B GAIN, BIAS values by using the [UP]/[DOWN]/[ENTER] buttons.

· Color Copy

In User mode, user can copy the preset of 3200K, 5600K, 6500K or 9300K to make the custom adjustment by using the [UP]/[DOWN]/[ENTER] button.

[3] MAIN - Marker



· Line Marker

This selects the marker type when the MARKER is displayed on the screen.

Compatible MARKER types are as follows:

MODE	MARKER CLASS
HD / SD 16:9	16:9, 4:3, 4:3 ON AIR, 15:9, 14:9, 13:9, 1.85:1, 2.35:1, 1.85:1 & 4:3
SD 4:3	16:9



- **Center Marker**

This item displays the CENTER MARKER on the screen.

- **Safety Area**

This item controls the size of the SAFETY AREA between 80%, 85%, 88%, 90%, 93%, and 100%.

- **Marker Mat**

This item darkens the area outside of MARKER setting area. The degree of the matte is between OFF(0) and (7).

The higher the number the darker MARKER the matte becomes.

- **Marker Color**

This item controls Marker color. Selectable colors are white, gray, black, red, green, and blue.

#Line Marker, Center Marker and Safety Area functions are operates only after activated by pressing the MARKER button on the front of the monitor

[4] MAIN - Remote

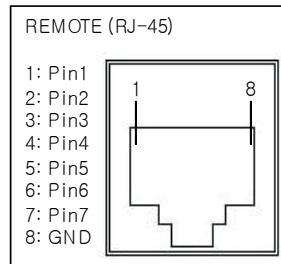

- **Pin1 ~ Pin6**

The user may connect RJ-45 jack to the remote terminal on the rear of the unit and designate a function for each pin.

The selectable functions are as follows:

Menu Classification	Settable Values
PIN 1~6	ANALOG CHANNEL DIGITAL A CHANNEL DIGITAL B CHANNEL TALLY RED TALLY GREEN BLUE ONLY UNDERSCAN ASPECT HVDELAY 16:9 MARKER, 15:9 MARKER, 14:9 MARKER, 13:9 MARKER, 4:3 MARKER, 4:3 ON AIR MARKER, 1.85:1 MARKER, 2.35:1 MARKER, 1.85:1 & 4:3 MARKER CENTER MARKER SAFETY AREA 80%, SAFETY AREA 85%, SAFETY AREA 88%, SAFETY AREA 90%, SAFETY AREA 93%, SAFETY AREA 100%

- Pin7
PIN7 is for POWER ON/OFF use only.

[5] MAIN - System [page1]

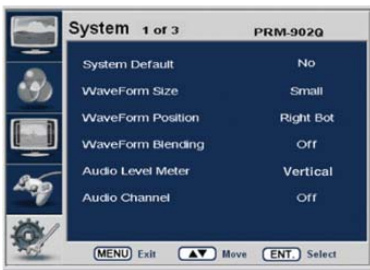

- System Default
User can use the System Default menu to initialize the values of the monitor.
- Waveform Size
This item controls the size of Waveform or Vector Scope.



· **Waveform Position**

This item controls the position of Waveform or Vector Scope between Right, Center and Left.

#In normal display, press Enter button to activate this feature in activated Waveform .

#This feature can be activated in small size mode only.

· **Waveform Blending**

This item activates the blending of Waveform or Vector Scope.

#This feather activates automatically if Waveform overlaps with OSD.

#This feather can be activated in small size mode only.

· **Audio Level Meter**

This item controls the position of audiolevel meter between Horizontal and Vertical.

· **Audio Channel**

This item sets embedded audio channel selects CH1 ~ CH16, Off..

#Waveform Size, Waveform Position and Waveform Blending functions are operates only after activated by pressing the WAVE/VECTOR button on the front of the monitor.

#Menus or feathers which are related with Waveform and Audio enables in SDI input mode only.

[6] MAIN - System [page2]

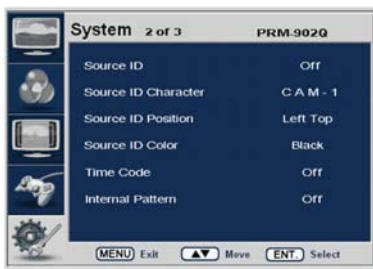

· **Source ID**

This item is used to activate the source ID display by selecting BG Type or Char Type.

- **Source ID Character**

This item is used to customize the Source ID display. (A~Z, a~z, 0~9 and special characters)

- **Source ID Position**

This item controls the position of Source ID display. (Top-Left, Top-Center, Top-Right, Bottom-Right, Bottom-Center, Bottom-Left)

- **Source ID Color**

This item is used to change the color of source ID display by selecting black, white, red, green, blue or yellow.

- **Time Code**

This item activates the Time Code. Select between VITC or LTC.

- **Internal Pattern**

This item used to activate the Internal Pattern of 100% White or 100% Color Bar.

[7] MAIN - System [page3]



- **Back Light**

This item controls the LED backlight setting. The value should be within range between MIN(0) and MAX(50).

- **Firmware Version**

This item is the firmware version of the system.

- **License**



[8] SDI A INPUT Menu	<ul style="list-style-type: none">• PRM-902Q Series unit is capable of processing single SDI A Input signal.• Press [SDI-A] button on the front of the monitor to select the SDI A input. OSD menu displays as shown on the left. <p>#If no image displays after selecting the desired input mode, check and make sure that your connection is not lose or disconnected.</p> <p>#Input resolution displays on the bottom of the OSD screen.</p>
[9] SDI B INPUT Menu	<ul style="list-style-type: none">• PRM-902Q Series unit is capable of processing single SDI B Input signal.• Press [SDI-B] button on the front of the monitor to select the SDI B input. OSD menu displays as shown on the left. <p>#If no image displays after selecting the desired input mode, check and make sure that your connection is not lose or disconnected.</p> <p>#Input resolution displays on the bottom of the OSD screen.</p>
[10] ANALOG INPUT Menu	<ul style="list-style-type: none">• PRM-902Q Series unit is capable of processing varied ANALOG Input signals• Press [ANALOG] button on the front of the monitor and activate the OSD menu as shown on the left. Select the input you desire by using the [UP]/[DOWN] button and press the [ENTER] button to confirm. <p>#If no image displays after selecting the desired input mode, check and make sure that your connection is not lose or disconnected.</p> <p>#Input resolution displays on the bottom of the OSD screen.</p>

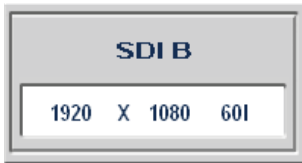
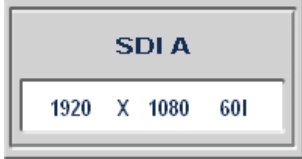

Other Functions

[1] PIXEL TO PIXEL

- PRM-902Q monitor's Pixel to Pixel mode displays input signal without scaling.
- To activate the [Pixel to Pixel] mode, access the Scan menu in System menu and select [Pixel to Pixel].
- In the [Pixel To Pixel] mode, use the [UP]/[DOWN] buttons to toggle between 1:1 scan sections

Input	Action Button	Available Modes
HD 1080i/1080p	[UP] (Clockwise)	Center -> Left Top -> Mid Top -> Right Top -> Right Mid -> Right Bottom -> Mid Bottom -> Left Bottom -> Left Mid -> Center -> ...
	[DOWN] (Opposite)	Center -> Left Mid -> Left Bottom -> Mid Bottom -> Right Bottom -> Right Mid -> Right Top -> Mid Top -> Left Top -> Center -> ...

- OSD change

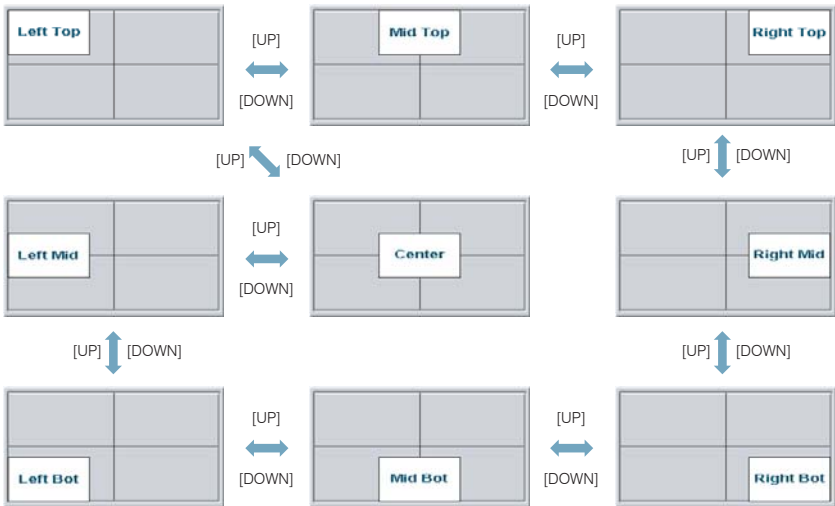



Input	Action Button	Available Modes
HD 720p	[UP] (Clockwise)	Center -> Left Top -> Right Top -> Right Bottom -> left Bottom -> Center -> ...
	[DOWN] (Opposite)	Center -> Left Bottom -> Right Bottom -> Right Top -> Left Top -> Center ->

- OSD change

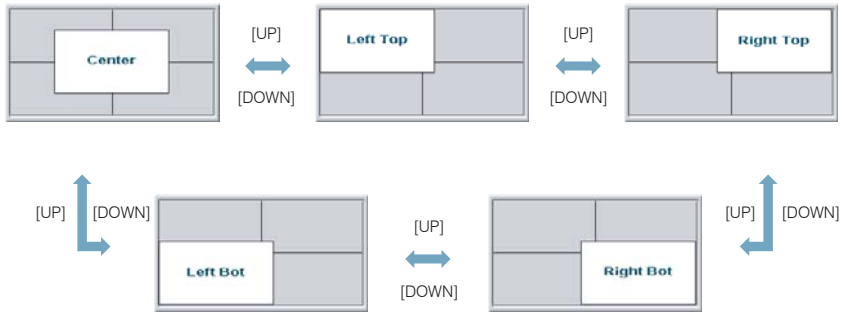

#Pixel To Pixel mode is available in SD mode, but 1:1 sections cannot be rotated through as with HD sources.

· Positions in HD Signal 1080i/1080p mode

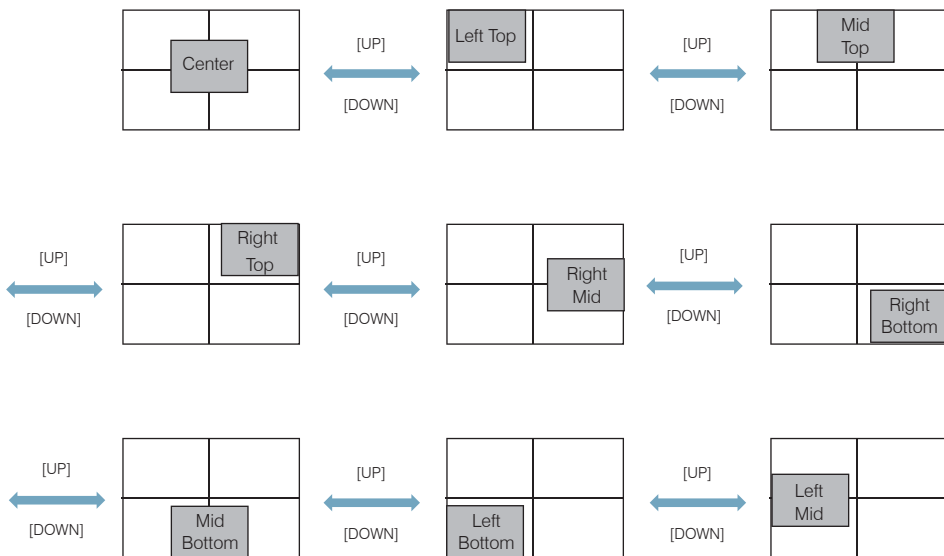

· Position in HD Signal 720p mode

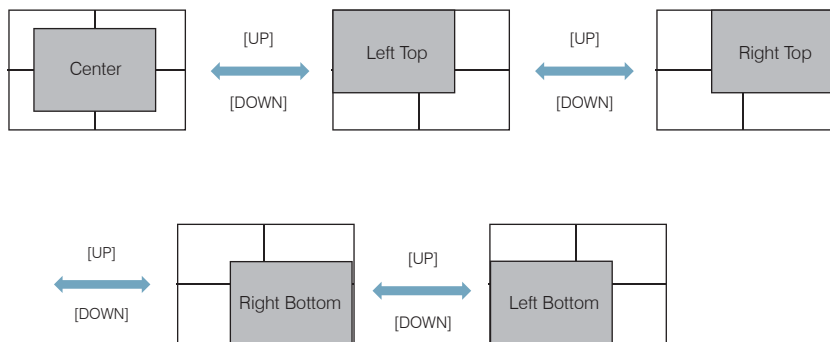



[2] Waveform

Small display : YCbCr → Y → Cb → Cr → Vector → off

Full display : Y → Cb → Cr → Vector → off

· Waveform

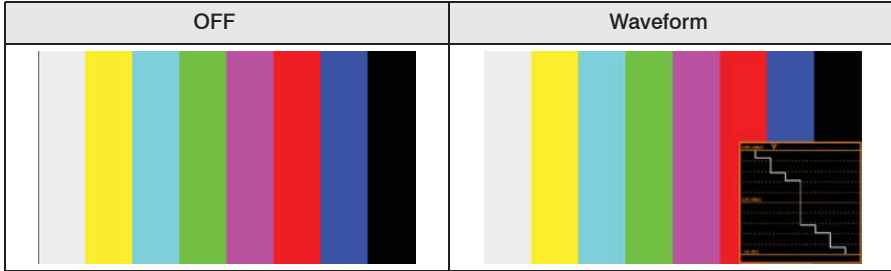

· Waveform Size

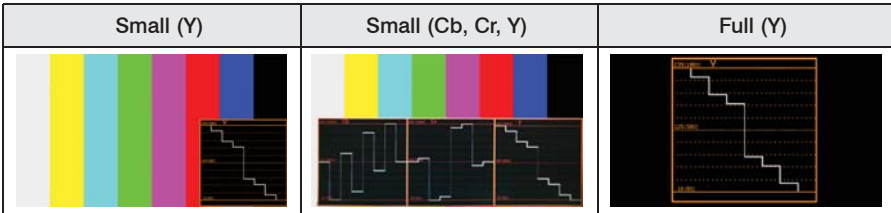

If push the Input button (SDI-A ,SDI-B and Analog), Waveform full mode is change to small mode automatically.

· Waveform Positions

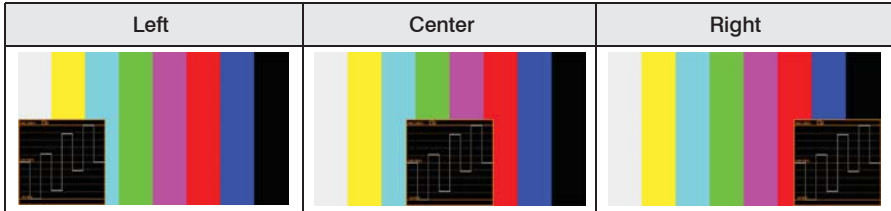

· Waveform Blending



· Exception: If overlaps with OSD, blending activates automatically.

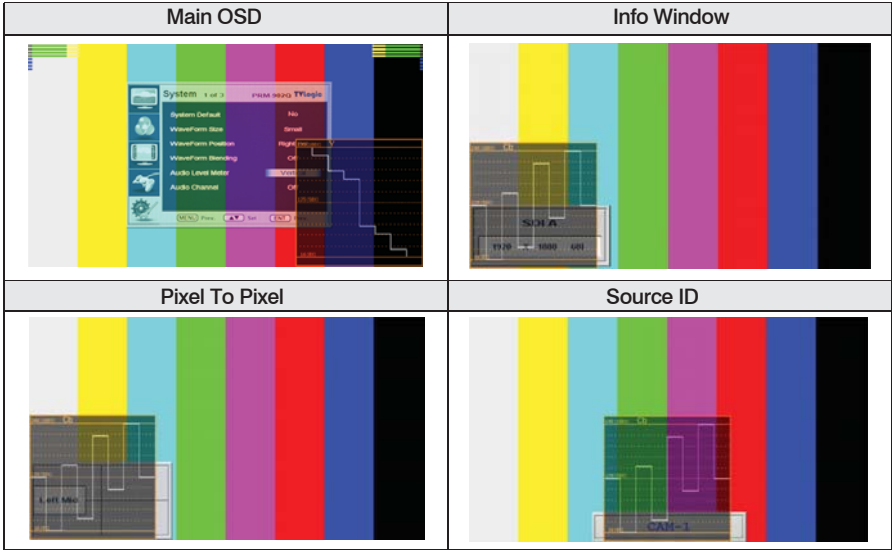

This function is only available with SDI Input.

[3] Vector Scope

· Vector Scope

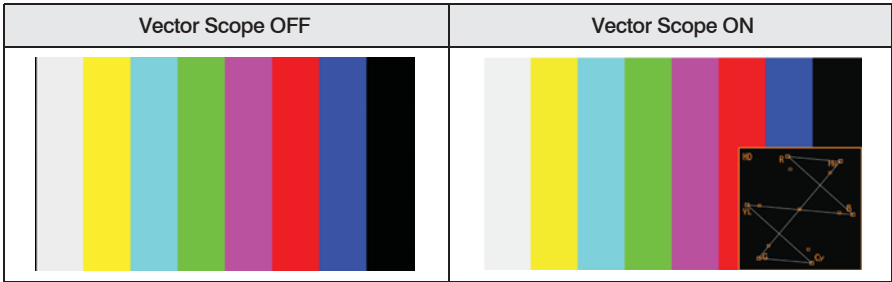

· Vector Scope Size

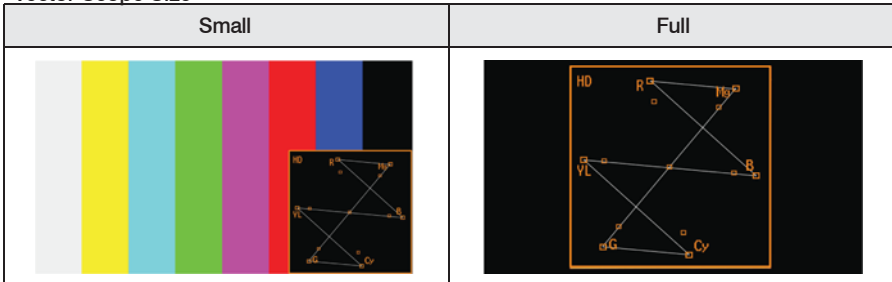



Vector Scope Position / Blending

: Refer to the Waveform position (P.18) and Waveform Blending (P.19)

This function is only available with SDI Input.

[4] Audio Level Meter

· Audio Level Meter

OFF	HORIZONTAL	VERTICAL
dBFS	BBC	EBU
VU	Nordic	



· Avoid Overlap

In full size WaveForm mode, WaveForm shifts down to avoid the overlap with Audio Level Meter.

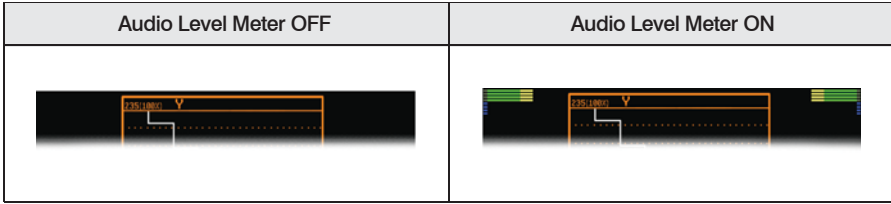

· Group & Channel

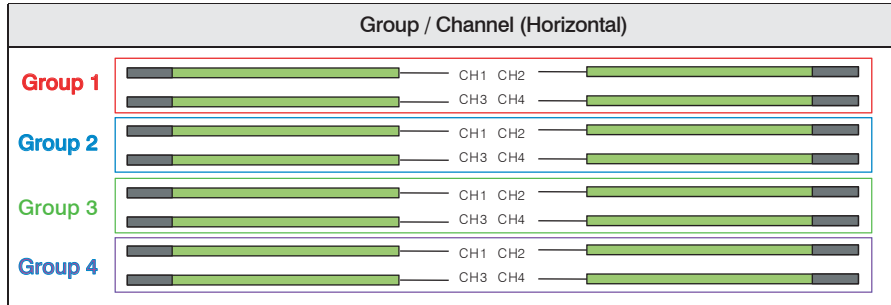



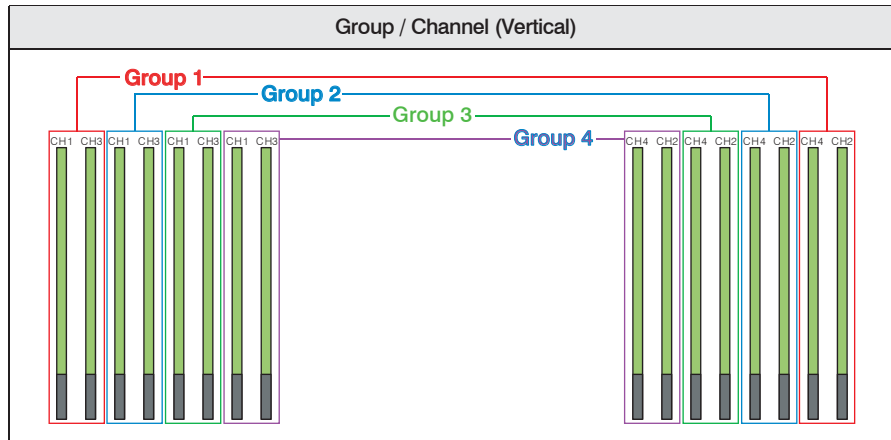

#This function is only available with SDI Input.



Other Functions





[5] Time Code

Time Code	Time Code + Audio Level Meter
	
Time Code + WaveForm Full Size	Time Code + SourceID + WaveForm + Audio Level Meter
	

#This function is only available with SDI Input.

[6] Source ID

· Source ID

BG Type	Char Type
	

· Source ID Position

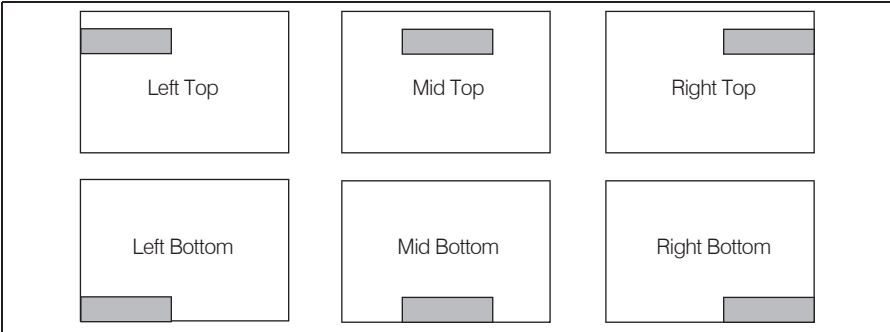

· Source ID Color

Black	White	Red	Green	Blue	Yellow
CAM-1	CAM-1	CAM-1	CAM-1	CAM-1	CAM-1

[7] MAIN - System [page3]

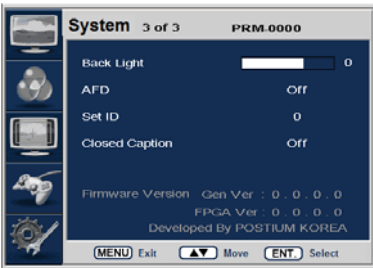

· **Back Light**

This item controls the LED backlight setting. The value should be within range between MIN(0) and MAX(50).

· **AFD**

This item activates the AFD mode. Selectable mode are Off, Aspect Mode and Marker mode. This feature action in only SDI signal included AFD Data. In Internal Pattern mode, this feature and menu disable automatically.

· **Set ID**

This item controls the Set ID setting for UMD. The value should be within range between 0 and 99.

· **Closed Caption**

This item controls closed caption ON/OFF.(708, 608(Line21), 608(ANC))

· **Firmware Version**

This item is the firmware version of the system.

· **License**



System Default Value

MEMU		Value
Picture	Brightness	0
	Contrast	0
	Chroma	0
	Aperture	0
	Phase	0
	NTSC Setup	7.5 IRE
Color	Color Temp	6500K
	Gain Red (1/2/3)	0
	Gain Green (1/2/3)	0
	Gain Blue (1/2/3)	0
	Bias Red (1/2/3)	0
	Bias Green (1/2/3)	0
	Bias Blue (1/2/3)	0
	Color Copy	6500K
Marker	Line Marker	Off
	Center Marker	Off
	Safety Area	Off
	Maker Mat	Off
	Marker Color	White
Remote	PIN 1	Analog Channel
	PIN 2	Digital A Channel
	PIN 3	Digital B Channel
	PIN 4	Tally R
	PIN 5	Tally G
	PIN 6	Blue Only
System [Page 1]	System Default	No
	Waveform Size	Small
	Waveform Position	Right Bot
	Waveform Blending	Off
	Audio Level Meter	Horizontal
	Audio Channel	Off
System [Page 2]	Source ID	Off
	Source ID Character	C A M – 1
	Source ID Position	Left Top
	Source ID Color	Black
	Time Code	Off
	Internal Pattern	Off
System [Page 3]	Back Light	Calibrated Value
System [Button]	Scan	Zero Scan
	Aspect Ratio	4:3
	Marker	Off
	HV Delay	Off
	Blue & Mono	Off
	Audio Level Meter	Off
	Waveform/Vector	Off

Specifications may be changed without notice.

Product Specification

Input (1 Screen)	3 x BNC	Analog Input
	1 x BNC	SDI 2 Channel Input
Output (1 Screen)	1 x BNC	SDI Output (Active Through Out)
Input Signal	Composite	1.0Vpp (With Sync)
	S-Video	1.0Vpp (Y With Sync), 0.286Vpp(C)
	Component	1.0Vpp (Y With Sync), 0.7Vpp (Pb,Pr)
	RGB	1.0Vpp (G With Sync), 0.7Vpp (B,R)
	HD-SDI	1.458Gbps
	SD-SDI	270Mbps
Analog Input Signal Formats	Composite / S-Video	NTSC (525/59.94i) , PAL (625/50i)
		480i (59.94) , 576i (50) , 480P (59.94) , 576P (50)
	Component / RGB (SOG)	1080i (60/59.94/50)
		1080P (30/29.97/25/24/24sF/23.98/23.98sF)
		720P (50/59.94/60)
SDI Input Signal Formats	SMPTE-274M	1080i (60/59.94/50)
		1080p (30/29.97/25/24/24sF/23.98/23.98sF)
	SMPTE-296M	720p (23.98/24/25/29.97/30/50/59.94/60)
	SMPTE-260M	1035i (60/59.94)
	SMPTE-125M	480i (59.94)
	ITU-R.BT.656	576i (50)
	2K Format	2048 X 1080 (23.98psf/24psf/23.98psf/24p)
Audio Out		Analog Stereo (Phone Jack)
		Internal Speaker 2 X 1W (Stereo)
LCD	Size	9.0 inch
	Resolution	960 x 3 (H) x 540 (V) (16:9)
	Pixel Pitch	0.207 (H) X 0.207 (V) mm
	Color	16.7M(true), 24bit
	Viewing Angle	H : 170 degrees
		V : 170 degrees
	Luminance of white	400 cd/m ² (Center)
	Contrast	1000:1
Display Area	198.72 (H) x 111.78 (V) mm	
Power	12V DC	
Power Consumption (Approx.)	36 Watts (DC)	
Operating Temperature	0°C to 40°C (32°C to 104°C)	
Storage Temperature	-20°C to 50°C (-4°F to 122°F)	
Main Body Dimensions (mm/inch)	442 x 170 x 63.2 (174 x 66.9 x 24.9)	
Main Body Dimensions (With Rack Bracket)	482 x 178 x 86.7 (189.6 x 70 x 34.1)	
Weight	3.6 kg / 7.936 lbs	
Accessory	DC Power Adapter	

Specifications may be changed without notice.

Postium korea

Postium Bldg. 2F, 433-34 Kalhyun-Dong,
Eunpyoung-Gu, Seoul, Korea

Tel : +82-2-354-6055

Fax : +82-2-354-6056

www.postium.com