

OBM-N/L/R Series

Professional Video Monitor

HDR



Operational Instructions

OBM-N170G

OBM-N180

OBM-N210

OBM-N240

OBM-N310

OBM-N420

OBM-N460

OBM-N550

OBM-L180

OBM-R210

OBM-H210



www.postium.co.kr / www.postium.com

Table of Contents

1. Precaution	3
2. Main Features	5
3. Location and Function of Parts and Controls	
Front Panel	6
Rear Panel	9
4. Using the Menu	12
5. Adjustment Using the Menus	13
6. OSD Menu Operations	
Status Menu	15
Color Temp/Color Space/Gamma Menu	16
Camera Assist Menu	17
User Configuration Menu	19
Remote Menu	23
Security Menu	24
7. Available Signal Formats	25
8. Key Functions	26
9. Product Specifications	31

1. Precaution

Always use set voltage.

AC 100 ~ 230V, 50/60Hz

DC 12V(OBM-N170G/N180/N210/N240/L180/R210/H210) or DC 24V(OBM-N310/N420)

All these instructions should be read and understood before operating the unit.

If liquid is spilled on or impacts this product, please disconnect the product immediately and seek professional help before continued use.

Unplug the product from the wall outlet if it is not to be used for several days or more. Unplug when happening something any problems.

Keep the product in a well-ventilated place to prevent overheating.

Do not install the product near any heat-generating equipment. Also, keep the product out of direct sunlight or dusty areas.

Protect the power cord from being walked on or pinched particularly at plugs, convenience receptacles, and the point where they exit from the apparatus. The power cord plug shall be connected to a MAINS socket outlet with a protective earthing connection.

When using other DC 12V(OBM-N170/N180/N210/N240/L180/R210) or DC 24V(OBM-N310/N420) adapters instead of the standard adapter provided by the manufacturer, please check the proper load capacity or current capacity and use an adapter with stable voltage.

Do not overload AC outlets or extension cords. Overloading can cause fire or electric shock.

When mounting the product be sure to install the product according to the recommended by the manufacturer.

A very small proportion of pixels may be stuck, either always off (black), always on (red, green, or blue), or flashing. In addition, over a long period of use, because of the physical characteristics of the liquid crystal display, such stuck pixels may appear spontaneously. These problems are not a malfunction.

If a fixed picture such as a frame of a divided picture or time code, or a still picture is displayed for a long time, an image may remain on the screen and be superimposed as a ghosting image.

The permanent burn-in may occur for LCD panel if still images are displayed in the same position on the screen continuously, or repeatedly over extended periods.

To reduce the risk of burn-in,

- a. Turn off the character displays.
- b. Turn off the power when not in use.
- c. Turn off the power if the monitor is not to be used for a prolonged period of time.

When mounting the product be sure to install the product according to the recommended by the manufacturer.

Do not attempt to service the product yourself. Removing covers can expose you to high voltage and other dangerous conditions. Request a qualified service person to perform servicing.

When the product needs replacement parts, make sure that the service person uses replacement parts specified by the manufacturer, or those with the same characteristics and performance as the original parts. Use of unauthorized parts may result in fire, electric shock and/or other danger.

Only clean the product with a noncommercial, mild and neutral detergent.

Do not throw away the carton and packing materials. When transporting the product, make use of its original packaging for safer carriage.



This mark indicates the possibility of injury or damage to property.



To identify any terminal which is intended for connection to an external conductor for protection against electric shock in case of a fault or the terminal of a protective earth (ground) electrode.

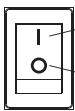

means Power on when pressing

means Power off when pressing

FCC (Federal Communications Commission)

This equipment has been tested and found to comply with the limits for class A digital device, pursuant to part 15 of the FCC Rules. These limits are designed to provide reasonable protection against harmful interference when the equipment is operated in a commercial environment. This equipment generates, uses, and can radiate radio frequency energy, and if not installed and used in accordance with the instruction manual, may cause harmful interference to radio communications. Operation of this equipment in a residential area is likely to cause harmful interference in which case the user will be required to correct the interference at his own expense.

⚠ Warning!! : Changes or modifications not expressly approved by the manufacturer could void the user's authority to operate the equipment.

Disposal of Old Electrical & Electronic Equipment

(Applicable in the European Union and other European countries with separate collection systems)



This symbol on the product or on its packing indicates that this product shall not be treated as household waste. Instead it shall be handed over to the applicable collection point for the recycling of electrical and electronic equipment. By ensuring this product is disposed of correctly, you will help prevent potential negative consequence for the environment and human health, which could otherwise be caused by inappropriate waste handling of this product. The recycling of materials will help to conserve natural resources.

2. Main Features

The OBM N series offers the superior picture quality and wide viewing angle, and includes an array of professional features and the advanced audio & video signal analysis functions including Waveform, Vector Scope, Audio Level Meter, IMD, Camera Log Selection, Custom 3D LUT Import, Focus Assist, etc. The OBM N series are equipped with various I/O interfaces such as 3G-SDI, HDMI, Component, Composite, DVI. The wide model lineup from 18.5" up to 55" provides the best solutions from the field production to monitoring in studio.

- 3G/HD/SD-SDI 2 Channel
- HDR(High Dynamic Range) Display supporting PQ EOTF(ST 2084), Hybrid Log Gamma, S-Log3
- 3D-LUT for Accurate Color Reproduction
- 1.064 Billion Colors
- Camera Log Conversion
- Camera Log Mapped SDI Loopout
- Custom 3D LUT File Import Through USB
- Gamma Selection (1.0 ~ 3.0)
- Color Temperature(3200K, 5500K, 6500K, 9300K, USER 1/2/3, D-CINEMA)
- Waveform, VectorScope (Wave + Vector, Waveform Wide, Position Change, Size Adjustment)
- Monitor Control via Ethernet, RS-422
- Various Markers (EBU, 4:3, 16:9, 1.85:1, 2.35:1, Variable etc.)
- White Internal Patterns Display for Color Test (Black ~ 100%, Color Bar)
- Easy Firmware Update by USB
- Focus Assist
- False Color (Zebra, False Color ARRI, False Color Variable)
- False Color Comparison
- Gamut Error
- Zebra
- HDR Waveform
- Zero Scan / 1:1 Scan
- H/V Delay
- Blue/Mono Only
- Time Code Display (Position/Size Selection)
- IMD (TSL V3.1/V5.0)
- De-embedded 8~16ch Audio Level Meter
- Remote Control via GPI(RJ-45) Port
- 3 Color TALLY Lamp
- Rack & VESA Mount (Option)
- Closed Caption(608, 708)
- System Data Copy
- Key Lock & Password Lock
- Aspect
- Freeze

3. Location and Function of Parts and Controls

Front Panel

-(OBM-N180/N210/N240/N310/N420/N460/N550/H210)

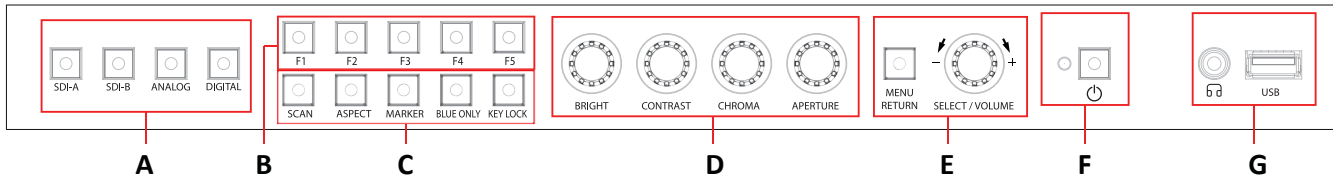

A : Input select Buttons/Lamp

Press to monitor the signal input to each connector.

-(OBM-N170G/N180/N210/N240/N310/N420/N460/N550/H210)

[SDI-A] Button/Lamp

- Press the button to select 3G SDI-1 input.

[SDI-B] Button/Lamp

- Press the button to select 3G SDI-2 input.

[ANALOG] Button/Lamp

- Press the button to select Analog Input.

- Mode changes in the order of [Composite], [Component].

[DIGITAL] Button/Lamp

- Press the button to select Digital input.

- Mode changes in the order of [HDMI], [DVI].

-(OBM-L180)

[SDI] Button/Lamp

- Press the button to select SDI input

[HDMI] Button/Lamp

- Press the button to select HDMI input

-(OBM-R210)

[SDI] Button/Lamp

- Press the button to select SDI input

- Mode changes in the order of [3G SDI-1], [3G SDI-2].

[SOURCE] Button/Lamp

- Press the button to select Analog & Digital input

- Mode changes in the order of [HDMI], [DVI], [COMPONENT], [COMPOSITE].

B : F1 ~ F5 Button/Lamp

Press to adjust or turn on/off the assigned function.

The following functions are assigned at the factory.

[F1]: HDR&Cam.Log Compare

[F2]: H/V Delay

[F3]: Color Temp

[F4]: Audio Level Meter

[F5]: Time Code

** OBM-L180 and OBM-R210 have [F1] button only.

(OBM-N170G) (OBM-L180) (OBM-R210)

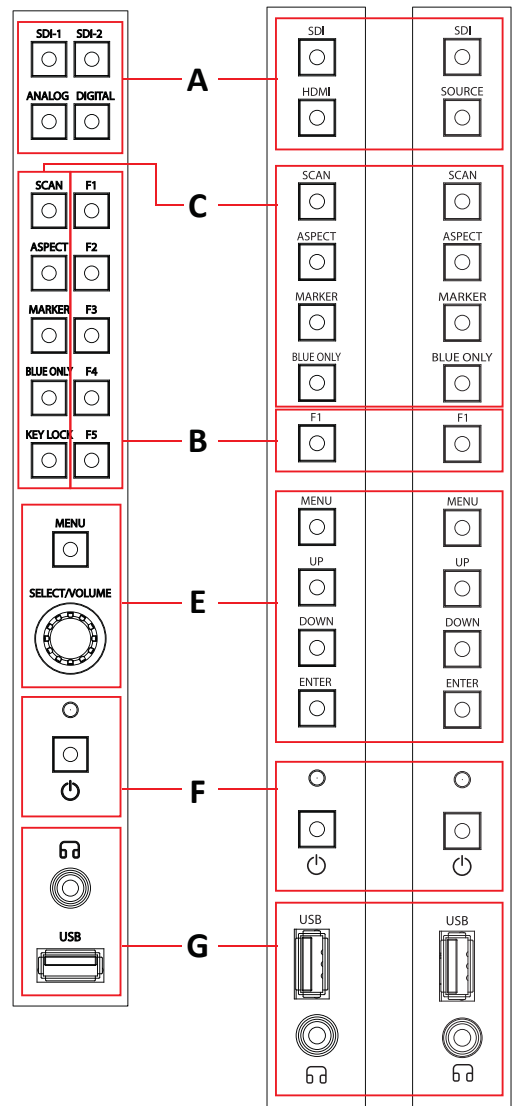

C : Function Button/Lamp

Press to adjust or turn/off each function.

[SCAN] Button- Press the button to adjust the scan mode. (Zero Scan, 1:1 Scan).

[ASPECT] Button- Press the button to select the Aspect Ratio of the signal.

- Mode changes in the order of [16:9], [4:3], [2.35:1], [1.85:1], [15:9], [16:10], [AUTO].

[MARKER] Button

- Press the button to activate and deactivate the Marker.

[BLUE ONLY] Button

- Press the button to activate and deactivate the Blue Only function.

- You may remove R(red) and G(green) from the input signal and display the screen only with B(blue) signal.

This function is convenient to adjust Chroma and Phase and to observe the signal noise.

- The button may be pressed twice to change the screen to MONO mode.

(This mode uses only Luminance value.)

[KEY LOCK] Button - Press the button to lock all buttons except Power.

** OBM-L180 and OBM-R210 don't have [KEY LOCK] button.

D : Rotary Encoder (OBM-N180/N210/N240/N310/N420/N460/N550/210)

[BRIGHT] knob

Press this knob to display the adjustment screen and adjust the picture brightness. Press again to hide the adjustment screen. Turn the knob right to increase the brightness and turn left to decrease it.

[CONTRAST] knob

Press this knob to display the adjustment screen and adjust the picture contrast. Press again to hide the adjustment screen. Turn the knob right to increase the contrast and turn left to decrease it.

[CHROMA] knob

Press this knob to display the adjustment screen and adjust the color intensity. Press again to hide the adjustment screen. Turn the knob right to increase the color intensity and turn left to decrease it.

[APERTURE] knob

Press this knob to display the adjustment screen and adjust the picture sharpness. Press again to hide the adjustment screen. Turn the knob right to make the picture sharper and turn it left to make the picture softer.

E : Menu Operation Buttons

Displays or sets the on-screen menu.

[MENU/RETURN]

- Activates and deactivates the display of the Main Menu.

- When the on-screen menu is not displayed, if this button is pressed the main menu is displayed.

When the menu is displayed, press the button to return to the previous menu.

-(OBM-N170G/N180/N210/N240/N310/N420/N460/N550/H210)

[SEL/VOL] knob (Menu selection control)

- When the menu is displayed, turn the knob to select a menu item or a setting value, and then press the knob to confirm the setting.

- If this knob is pressed when the menu is not displayed, the adjustment screen of [VOLUME] is displayed to adjust the audio volume.

- Press this knob to change the modes in the order of [Focus Frequency], [Zebra Level], [Line Position], [Variable Marker] and adjust each mode's value.

[Focus Frequency]: When Focus Assist function is activated, this mode is displayed.

[Zebra Level]: When Zebra function is activated, this mode is displayed.

[Line Position]: When WFM/Vector function and Line Select function is activated, this mode is displayed.

[Variable Marker]: When Marker function is activated and Aspect Marker is set Variable, this mode is displayed.

(OBM-L180/R210)

[UP] Button

- When the menu is displayed, press the button to select a menu item or increase the value.

[DOWN] Button

- Press the button to select the Aspect Ratio of the signal.
- When the menu is displayed, press the button to select a menu item or decrease the value.

[ENTER] Button

- Used to confirm the setting.
- If this knob is pressed when the menu is not displayed, the adjustment screen of [VOLUME] is displayed to adjust the audio volume.
- Press this knob to change the modes in the order of [Focus Frequency], [Zebra Level], [Line Position], [Variable Marker] and adjust each mode's value.
 - [Focus Frequency]: When Focus Assist function is activated, this mode is displayed.
 - [Zebra Level]: When Zebra function is activated, this mode is displayed.
 - [Line Position]: When WFM/Vector function and Line Select function is activated, this mode is displayed.
 - [Variable Marker]: When Marker function is activated and Aspect Marker is set Variable, this mode is displayed.

F : (Standby) Switch and Indicator

- Press to turn the power on when this monitor is in standby mode. After being turned on, the monitor performs initialization and the indicator flashes in green.
- Press the switch again for a second to set the monitor in standby mode. Then, the indicator flashes in orange and then turns red. The indicator in orange means that the monitor goes into the standby mode.
 - When the indicator flashes in orange, this button doesn't work.

G : (headphone) Jack and USB connector**Headphone Jack**

- The audio signal which is selected using the input select button is output in stereo sound.
- When SDI signals are input, the audio signals of the channels selected with SDI Audio Setting in the User Configuration menu are output.
- When the headphone is connected to the headphone jack, audio signals will not be output from speakers.

[USB] Connector

- To update CPU, GPU, FPGA program.
- To connect the monitor with the Color Calibration program provided by the manufacturer and perform the color calibration.
- To connect the monitor with the control program provided by the manufacturer and control functions remotely.
- To import the custom 3D LUT file (*.cube, 32^{^3}, 33^{^3}, 64^{^3} and 65^{^3}).

H : IR Receiver (OBM-R210/N420/N460/N550)

- Receives signals from the remote control.

Rear Panel

-(OBM-N170G/N180/N210/N240/N310//N420/N460/N550/R210/H210)

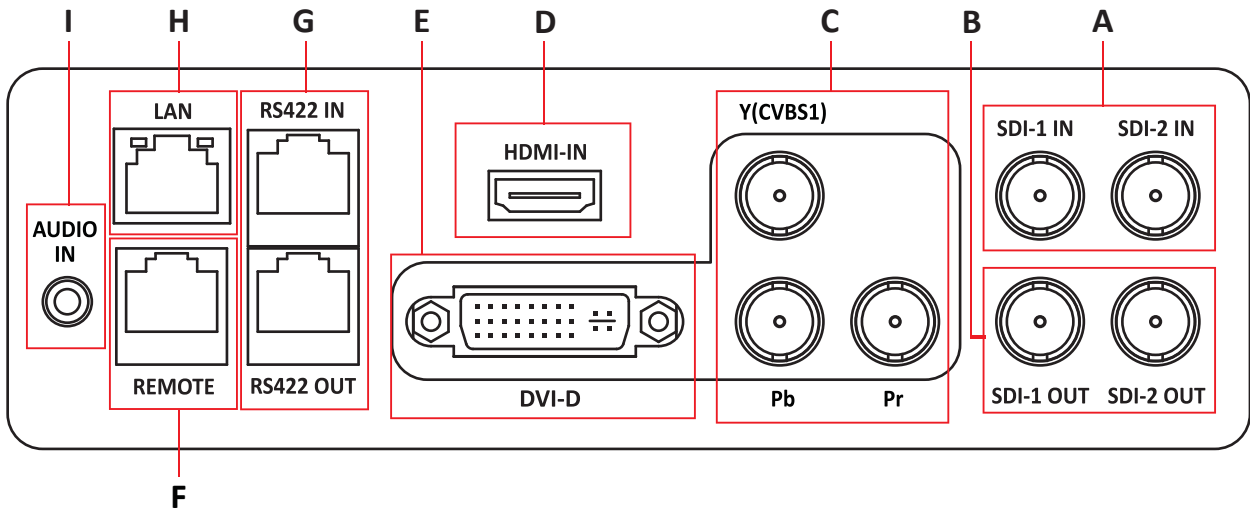

-(OBM-L180)

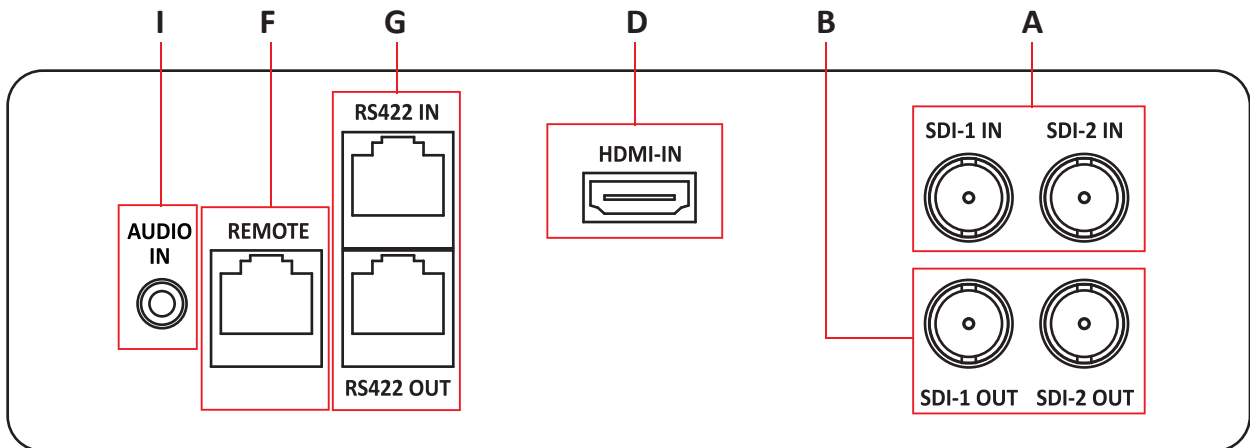

A : SDI IN (SDI Input) connectors (BNC)

Input connectors for SDI signals.

B : SDI OUT (SDI Output) connectors (BNC)

Output connectors for SDI signals.

Each connector outputs the signal which is input to the corresponding SDI IN connector.

****Note** - Output is activated only when the power is on. Output is not activated in standby mode.

C : Analog Input connectors

Input connectors for analog signals (CVBS, Component).

D : HDMI Input connectors

Input connector for HDMI signals.

E : DVI-D Input connector

Input connector for DVI signal.

F : PARALLEL REMOTE connector(RJ-45, 8-pin)

Forms a parallel switch and controls the monitor externally.

****Note** - For safety, do not connect the connector for peripheral device wiring that might have excessive voltage to this port. Follow the instructions about this port.

[Pin Assignment]

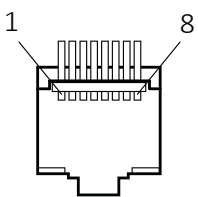

Functions can be changed in [Remote] section of the menu.

Pin Number	Function
1	3G SDI-1
2	3G SDI-2
3	Analog
4	HDMI
5	Zero Scan
6	1:1 Scan
7	Power
8	GND

G : SERIAL REMOTE IN/OUT connector (RJ-45)

Used for the future function expansion.

Connects the monitor to control the program provided by the manufacturer by using RS-422/485 communication or the external UMD(IMD) equipment and controls the monitor.

H : LAN(10/100) IN/OUT connector

Used for the future function expansion.

Connects to the LAN (10/100) connector of the network by using 10BASE-T/100BASE-TX LAN cable.

A daisy chain connection using the LAN input/output connectors enables the control of multiple monitors in sequence.

I : AUDIO IN connector (Stereo mini jack)

Connector for analog audio input.

Analog input can be selected with SDI Audio Setting in User Configuration menu.

J : DC IN terminal

Connects the DC power supply to the monitor.

- OBM-N170G / N180 / N210 / N240 / L180 / R210 : 12V
- OBM-N310 / N420 / H210 : 24V

Make sure to use DC 12V power supply for OBM-N170/N180/N210/N240/L180/R210 and DC 24V power supply for OBM-N310 / N420.

OBM-N170G/N180/N210/N240/L180/R210

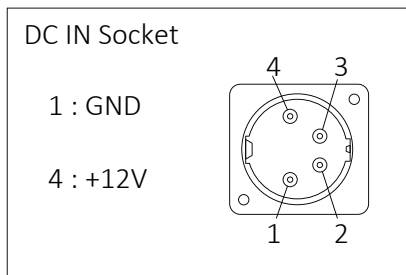

OBM-N310/N420/H210

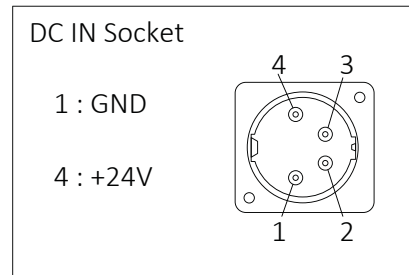

K : AC IN terminal

AC power input connector.

Connects the provided AC power cord.

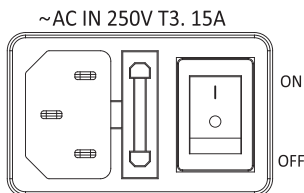

4. Using the Menu

This monitor is equipped with an OSD menu to make various adjustments and settings such as picture control, input setting, set setting change, etc.

1. Press the MENU button.

The menu appears.

The menu presently selected is shown in gray.

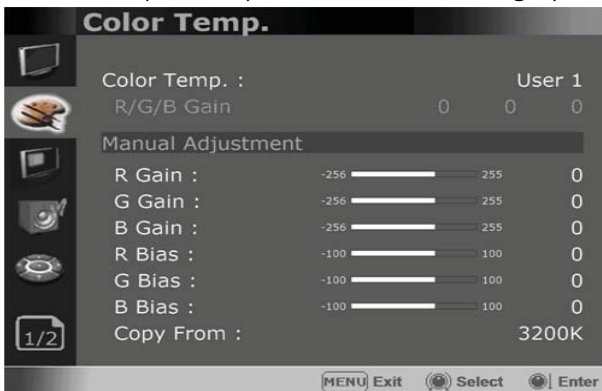

2. Turn SEL/VOL knob to select a menu, then press the knob.

The menu icon presently selected is shown highlighted

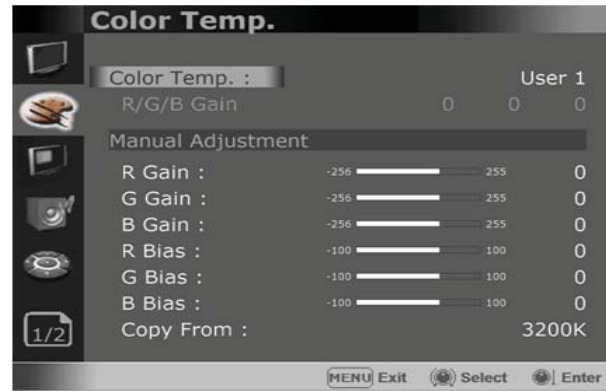

3. Select an item.

Turn the SEL/VOL knob to select the item, then press the knob.

The item to be changed is shown highlighted, and the sub menu is displayed on the right.



4. Make the setting or adjustment on an item.

How to change the adjustment level:

To increase the level, turn the SEL/VOL knob right.

To decrease the level, turn the SEL/VOL knob left.

How to change the setting:

Turn the SEL/VOL knob to change the setting, then press the knob to confirm the setting.

****Note** - An item displayed in gray cannot be accessed. The item is accessible if it is displayed in white.

To return the display to the previous screen:

Press the MENU button.

To clear the menu:

Press the MENU button.

5. Adjustment Using the Menu

The OSD menu of this monitor consists of the following items.



Status menu (To indicate the current settings)

- Format
- Color Temp
- Brightness
- Contrast
- Chroma
- Aperture
- Color Space
- Gamma
- User Preset
- RGB Range
- Back Light
- WFM/Vector
- Audio Level Meter
- Focus Assist
- Time Code
- Volume
- SDI Input
- SDI Payload ID
 - Identifier
 - Sampling
 - Picture Rate
 - Scanning Method
 - Bit Depth
 - Link Assignment
- Model Name
- Serial Number
- Board Version
- Operation Time
- Last Calibration Time



Color Temp./Color Space/Gamma menu

- Color Temp. ——— R/G/B Gain
- Manual Adjustment
 - R Gain
 - G Gain
 - B Gain
 - R Bias
 - G Bias
 - B Bias
 - Copy From
- Color Space
- OBM-HDR ——— Type
- Gamma
- Gamma Log
 - Default Log Sel.
 - User Log Sel.
- Back Light
- HDR&Cam.Log Comparison



Camera Assist menu

Zebra & False Color

- Zebra Level Adjustment
- Zebra Range
- Variable White Clipping
- Variable Pink Level
- Variable Green Level
- Variable Black Clipping

False Color Comparison

- Wipe Position

Focus Assist

- Color
- Frequency

Gamut Error

- Type
- Color Space
- Y Maximum
- Y Minimum
- Chroma Maximum
- Chroma Minimum
- RGB Maximum
- RGB Minimum



User Configuration menu

- User Preset Setting — Load
Save
- Function Button Setting
 - F1 Button
 - F2 Button
 - F3 Button
 - F4 Button(OBM-N090 only)
 - F5 Button(OBM-N090 only)
- Input Setting — 3G Signal Format
RGB Range
- Output Setting
 - Camera Log Mapped SDI Loopout
- Speaker Out / Audio Level Meter Setting
 - SDI Left Speaker Out
 - SDI Right Speaker Out
 - HDMI L/R Speaker Out
 - Audio Level Meter — Display
Reference
Size/Transparency
Peak Hold Time
Display Type
- Marker Setting
- Marker
 - Aspect Marker — Variable Aspect
 - Center Marker
 - Area Marker
 - Color
 - Aspect Mat
 - Fit
 - Thickness
 - Custom H1
 - Custom H2
 - Custom V1
 - Custom V2
- WFM/Vector Setting
- WFM/Vector — Type
 - Intensity
 - Transparency
 - Color
 - Line Select
 - Line Position
 - Position

- Closed Caption Setting — Closed Caption
Type
708
608
- System Setting — Internal Pattern
Key LED
OSD Time
OSD position
System Data
- Time Code
- Time Code Position/Size



Remote menu

- Parallel Remote
 - 1 Pin
 - 2 Pin
 - 3 Pin
 - 4 Pin
 - 5 Pin
 - 6 Pin
 - 7 Pin
 - 8 Pin
- Monitr ID
- In-Monitor Display Setting
 - IMD Type
 - Transparency
 - Text Color
 - Left Tally Color
 - Right Tally Color
- Network Setting
 - DHCP
 - IP Address
 - Subnet Mask
 - Gateway
 - Port No.
-  **Security Setting**
 - Key Lock
 - Password
 - User Parameter Lock
 - Change Password

6. OSD Menu Operations



Status Menu

The Status menu displays the current status of the monitor. The following items are displayed.

Page 1/4

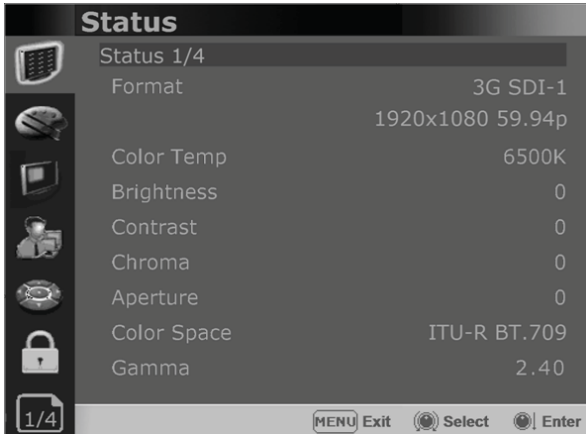

- Format
- Color Temp
- Brightness
- Contrast
- Chroma
- Aperture
- Color Space
- Gamma

Page 2/4



- User Preset
- RGB Range
- Back Light
- WFM/Vector
- Audio Level Meter
- Focus Assist
- Time Code
- Volume

Page 3/4

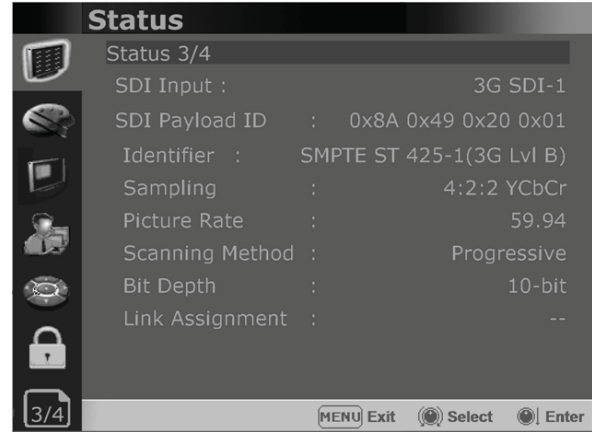

- SDI Input
- SDI Payload ID
- Identifier
- Sampling
- Picture Rate
- Scanning Method
- Bit Depth
- Link Assignment

*** When the SDI signal is connected, these items are displayed.

Page 4/4

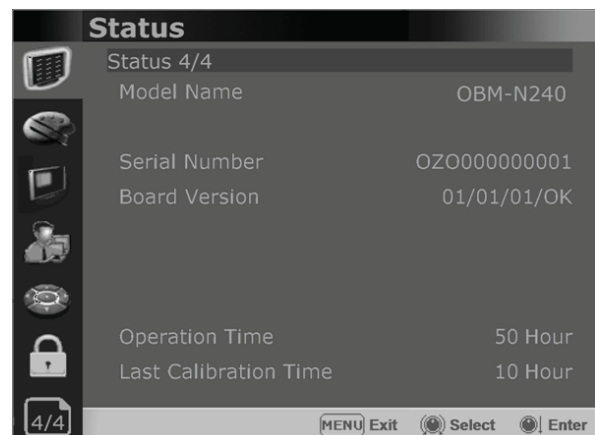

- Model Name
- Serial Number
- Board Version
- Operation Time
- Last Calibration Time



Color Temp/Color Space/Gamma Menu

These menus are used for adjusting or setting the color temperature, color space or gamma of the picture.

Page 1/2

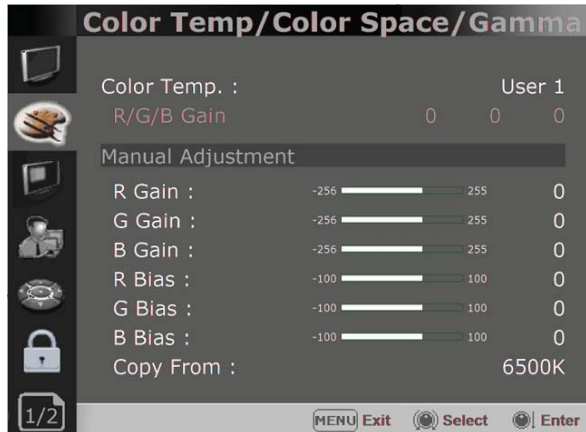

Color Temp

- Selects the color temperature from among [3200K], [5500K], [6500K], [9300K], [User1], [User2], [User3], [DCI-P3].

R/G/B Gain

- Displays the R/G/B Gain of the current Color Temperature.

Manual Adjustment

- If you set the Color Temp. to User 1/2/3, the item is changed from black to white, which means you can adjust the color temperature.

R/G/B Gain/Bias

- Adjusts the color balance(Gain, Bias).

Copy From

- The Gain and Bias data of each Color Temp. are restored to User adjustment.

Page 2/2



Color Space

- Selects the color space between [ITU-R BT.709], [Native].

HDR-EOTF

Selects whether to enable or disable the HDR-EOTF setting.

Type

Selects the mode of HDR gamma.

- ST 2084-300 : This mode displays the absolute brightness up to 300 cd/m². So, the highlights over 300 cd/m² are clipped.
- ST 2084-1000 : This mode displays the relative brightness up to 1000 cd/m². The part exceeding 1000 cd/m² is clipped.
- HLG-1.0 / 1.1 / 1.2 / 1.3 / 1.4 / 1.5 : These modes allow the user to apply HLG from 1.0 up to 1.5.
- S-Log3: Select the S-Log3(HDR) gamma.

Gamma

Selects the appropriate gamma mode from 1.00 to 3.00.

****Note**

- When the OBM-HDR is set Off, this menu becomes activated.
- When the color space is set to Native, this menu becomes deactivated.



Color Temp/Color Space/Gamma Menu

Camera Log

- | Selects a camera log for the input signal.
- | [Off]: Sets off the camera log.
- | [Default]: The log which is selected in [Default Log Sel.] menu is applied.
- | [User]: The log which is selected in [User Log Sel.] menu is applied.
- | [Import Log Data]: Allows the user to save the Log LUT in USB memory stick to the monitor. The saved LUT can be used in User Log.

Default Log Sel.

| Allows the user to select a camera log among C-Log, Log-C EI 160~3200, S-Log2 To LC-709, S-Log2 To LC-709TypeA, S-Log2 To Slog2-709, S-Log2 To Cine+709, S-Log2 To LC-709, S-Log3 To LC-709TypeA, S-Log3 To Slog2-709, S-Log3 To Cine+709, J-Log1.

User Log Sel.

| Selects User Log 1 to 4.

****Note**

- If you insert the USB memory stick which contains the user log data to the monitor and push Enter in [Import Log Data] menu, the data is saved to the monitor.
- The file name of the user log data is displayed on the OSD up to 15 characters, and the log data file should be placed on the top folder of the USB memory stick.

Ex) If the file name is 'S-log3 to LC709_A.cube', it is displayed as 'S-log3 to LC709' on the OSD.

Back Light

- Adjusts the level of the back light level. If the back light value is increased, the screen becomes brighter.

** If the setting in Color Temp. menu and Color Space menu is changed, the value of Back Light returns to the default value of the color calibration in the factory.



Camera Assist Menu

Page 1/3



Zebra & False Color

- Evaluates the Luma(Y') level of the input image. If the certain Y' level is set, the pixels with the designated Luma(Y') level are displayed in zebra pattern.

Zebra

| Pixels with Y' level over 100% turn to red zebra pattern, and pixels with Y' level under 0% turn to green zebra pattern.

Zebra Level Adjustment

- Adjusts the Y' level as the user wants.

Zebra Range

- Adjusts the Y' level as the user wants

False Color ARRI

The color pattern is displayed with ARRI camera standard.

Color	Level	Description
red	99~100%	White clipping
yellow	97~99%	Just below white clipping/white shoulder
pink	52~56%	One stop over medium gray (Caucasian skin)
green	38~42%	18% neutral gray
blue	2.5~4.0%	Just above black clipping/black slope
purple	0~2.5%	Black clipping

False Color Variable

| This mode allows the user to adjust White clipping, Pink level, Green level, Black Clipping.

Variable White Clipping

- Adjusts White Clipping from 0 to 1023.

Variable Pink Level

- Adjusts Pink level from 0 to 1023.

Variable Green Level

- Adjusts Green level from 0 to 1023.

Variable Black Clipping

- Adjusts Black Clipping from 0 to 1023.



Camera Assist Menu

False Color Comparison

- Allows the user to divide the picture side by side and compare the original image on the left half and the False Color image on the right half.

Wipe Position

Adjusts the boundary line of the left and right area. Allowed to adjust the boundary line by using the SEL/VOL knob.

Page 2/3



Focus Assist

- Controls the aperture level of a video signal and displays images on screen with sharpened edges to help camera focus operation.

Available types are [Color On] and [Mono On].

- [Color On]: The background image is the original color type.
- [Mono On]: The background image is the mono type.

Color

- Selects a color for Focus Assist among [RED], [Green], [Blue], [White], [Yellow], [Cyan], [Magenta].

Frequency

- Adjusts the edge difference level between the edges in an image.
- Available values are from 0% to 100%.

Page 3/3



Gamut Error

Based on the color space set below, Y, CB, CR, R, G, B The gamut error part that is out of range is displayed in zebra or mono.
On/off

Type

- Black Zebra: Show out-of-range areas as black zebra
- Black & White Zebra: Shows out-of-range areas as black or white zebra
- Mono: The part out of range is displayed in the corresponding color, and the part that is not out of range is displayed in mono

Color Space

Selects the target color space among [ITU-R BT.601], [ITU-R BT.709], [ITU-R BT.2020].
- The default values of Y Maximum/Minimum, Chroma Maximum/Minimum, RGB Maximum/Minimum are in compliance with EBU R 103 standard. And, the values can be adjusted by the user.

**** Default Values**

YCbCr	RGB
Y Maximum : 984	Maximum : 984
Y Minimum : 20	Minimum : 20
Chroma Maximum : 1004	
Chroma Minimum : 19	



User Configuration Menu

User Configuration consists of the adjustment menus such as [User Preset],[Function Button Setting],[Input Setting],[Output Setting],[Speaker Out / Audio Level Meter Setting],[Marker Setting],[W-FM/Vector Setting], [Closed Caption Setting],[System Setting].

Page 1/8



User Preset Setting

[Load] : Load the saved settings in [User Preset1], [User Preset2], [User Preset3], [User Preset4], [User Preset5] and [Factory Preset].

[Save] : Save the current setting status to [User Preset1], [User Preset2], [User Preset3], [User Preset4], or [User Preset5].

** When [User Preset Lock] of [Password] is set [On], [User Preset 1] setting values are protected by password. If you want to save the changed setting values to [User Preset 1], you can enter the password first to set [User Preset Lock] to [Off] and then save the values.

Function Button Setting

- Assigns the function for F1 to F5 buttons on the front panel.

The following functions can be assigned. :

[H/V Delay],
[Color Temp.],[Audio Level Meter],[Time Code],
[Zebra&Falst Color],[Focus Assist], [WFM/Vector],
[Camera Log],[Closed Caption], [HDR-EOTF],
[Freeze],[Fast Mode],[False Color Compare],
[Gamut Error],[Cam. Log Mapped SDI-Out],
[Back Light] ,[ST 2084- 1000] ,[User Preset1],
[User Preset2] ,[User Preset3] ,[User Preset4],
[User Preset5] ,[Zoom]

- The following functions are assigned in the factory.

[F1 Button] : H/V Delay
[F2 Button] : Color Temp
[F3 Button] : Audio Level Meter
[F4 Button] : Time Code

Page 2/8

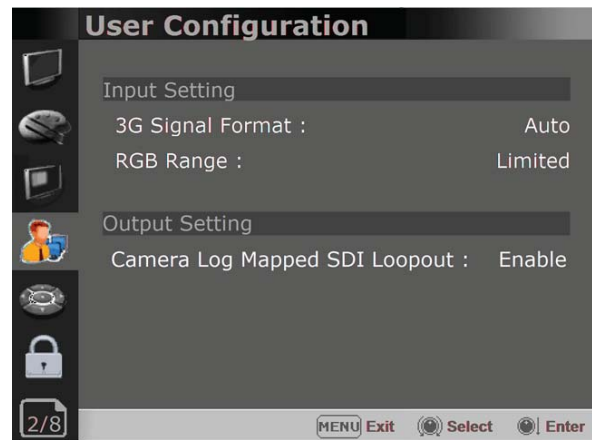

Input Setting

3G Signal Format

- Selects the format of 3G SDI input signal.
: [Auto],[A 4:4:4 YUV 10b],[A 4:4:4 GBR 10b],
[A 4:4:4 YUV 12b],[A 4:4:4 GBR 12b],
[A 4:2:2 YUV 12b],[B DL 4:4:4 YUV 10/12b],
[B DL 4:4:4 GBR 10/12b],[B DL 4:2:2 YUV 12b],
[B DL 4:2:2 YUV 10b 60p]

RGB Range

- Selects Black Level and White Level of RGB format.
*Limited : 64(10bit)/256(12bit) ~
1023(10bit)/4095(12bit)
*Full: 0(Black Level) ~ 1023(10bit)/4095(12bit)

Output Setting

Camera Log Mapped SDI Loopout

This function enables the camera log to be loaded to the original image and then sends the camera log mapped image to another monitor through SDI loop out.

Page 3/8

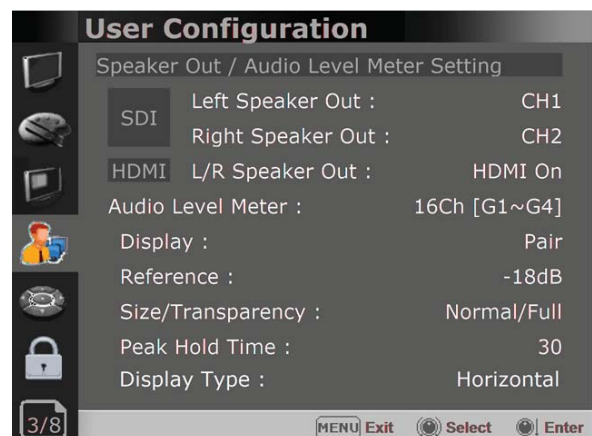



User Configuration Menu

Speaker Out / Audio Level Meter Setting

- Selects the audio channel of the SDI & HDMI input signal.

SDI : Left Speaker Out / Right Speaker Out

- Selects the embedded audio channel for the left and right audio out of the Headphone jack on the front panel of the monitor. Audio channel can be selected among Ch1 ~ Ch16, Analog.

HDMI : L/R Speaker Out

- Selects the embedded audio channel of the HDMI signal. The available modes are [Off], [HDMI On], [Analog On].

Audio Level Meter Setting

Selects the embedded audio mode.
: [Off], [8Ch [G1+G2]], [8Ch [G2+G3]], [8Ch [G3+G4]], [8Ch [G1+G3]], [8Ch [G1+G4]], [8Ch [G2+G4]], [16Ch [G1~G4]]
** In HDMI input, either [Off] or [HDMI 2Ch] can be selected.

Display

Selects the display method for Audio Level Meter. Available modes are [Group] and [Pair].
** In HDMI input, the mode is fixed to [Pair].

Reference

Selects the default value of Audio Level Meter. Available options are [-18dB] and [-20dB].

Size/Transparency

Selects the size and transparency of Audio Level Meter. Available options are [Normal/Full], [Normal/Half], [Large/Full], [Large/Half].

Peak Hold Time

Controls the speed rate of Peak Hold Decay Time occurring when the audio volume decreases.

Display Type

Selects the display type form Audio Level Meter. Available modes are [Horizontal] and [Vertical].

Page 4/8

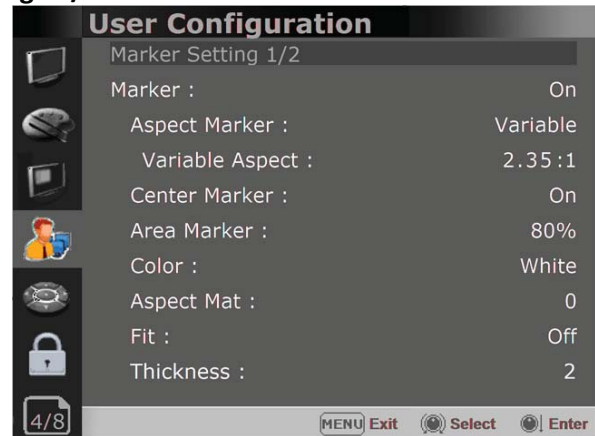

Marker Setting

Marker

- Selects On to display the marker, and Off to deactivate it.

Aspect Marker

Selects the aspect ratio of the marker. You can select from among [Off], [16:9], [4:3], [4:3 ON AIR], [15:9], [14:9], [13:9], [1.85:1], [2.35:1], [2.39:1], [1.85:1 & 4:3], [1.66:1], [1.896:1], [Variable].

***Variable Aspect**

Allows the user to select the aspect ratio from the range between 1.00:1 and 3.00:1.

Center Marker

Selects On to display the center marker and Off not to display it.

Area Marker

Selects the size of the area marker. You can select from among [Off], [80%], [85%], [88%], [90%], [93%], [100%], [EBU Action 16:9], [EBU Graphic 16:9], [EBU Action 14:9], [EBU Graphic 14:9], [EBU Action 4:3], [EBU Graphic 4:3].

Color

Selects the color of the marker. You can select from among [White], [Gray], [Red], [Green], [Blue], [Yellow], [Cyan], [Magenta].

Aspect Mat

Darkens the outside of the area of the Aspect Marker. You can select from 0 to 7.

Fit

With Fit On, the Area Marker is displayed relative to the Aspect Marker in use.

With Fit Off, the Area Marker is displayed relative to the incoming video source.

Thickness

Adjusts the thickness of the marker lines. You can select it from 1 to 7.



User Configuration Menu

Page 5/8

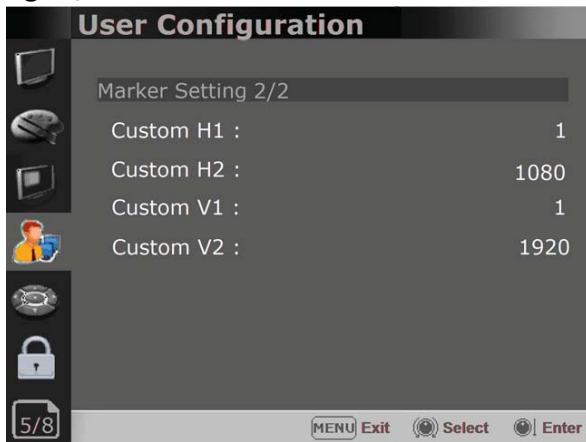

Marker Setting 2/2

Custom H1

- Adjust the first line of the panel height.
- [Custom] must be selected in [Aspect Marker] displayed

Custom H2

- Adjust the second line of the panel height.
- [Custom] must be selected in [Aspect Marker] displayed.

Custom V1

- Adjust the first line of the panel width.
- [Custom] must be selected in [Aspect Marker] displayed.

Custom V2

- Adjust the second line of the panel width.
- [Custom] must be selected in [Aspect Marker] displayed.

Page 6/8

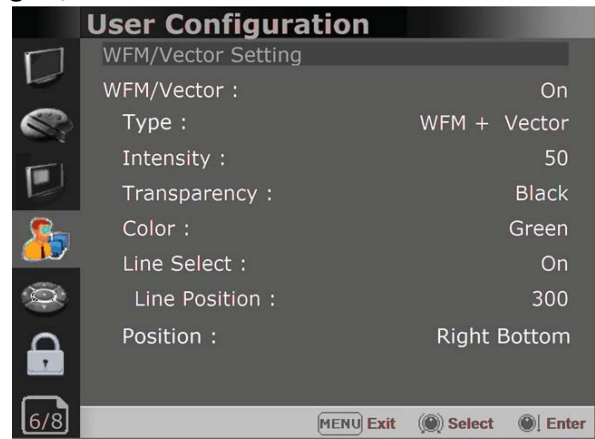

WFM/Vector Setting

WFM/Vector

- Select [On] to display the [WFM/Vector] and [Off] not to display.

Type

- Sets to activate and deactivate Waveform monitor and Vectorscope. You can select from among [WFM], [VectorScope], [WFM+Vector], [WFM Wide]. *This function doesn't work when RGB format signal is input.

Intensity

- Adjusts the brightness of Waveform and Vectorscope display. You can select from 1 to 64.

Transparency

- Adjusts the transparency level of Waveform and Vectorscope. [Black]: The background is black. Displayed image is hidden behind the background. [Half]: The background is transparent. Displayed image can be seen indistinctly behind the Waveform and Vectorscope display.

Color

- Selects the color of Waveform monitor. Available colors are [Green] and [White].

Line Select

- Selects [On] to display the Waveform of the line assigned in [Line Position] below.

***Line Position**

- Selects the specific horizontal line for Waveform and Vectorscope. Increases the value to move the line upwards and decreases the value to move the line downwards.

Position

- Sets the display position of the [WFM/Vector]. Selects [Right Bottom], [Left Bottom], [Left Top], or [Right Top].



User Configuration Menu

Page 7/8



Closed Caption Setting

Closed Caption

Selects [On] to display the Closed Caption and [Off] not to display.

Type Sets the Closed Caption type.

[708]: Selects this mode to display 708 when HD-SDI signal is input.

[608(VBI)]: Selects this mode to display 608(VBI) when SD-SDI signal is input.

[608(708)]: Selects this mode to display 608(708) when HD-SDI signal is input.

708 Sets the Closed Caption type for 708. Selects from [Service1] to [Service6].

608 Sets the Closed Caption type for 608(708) and 608(VBI). Selects from [CC1] to [CC4].

Page 8/8

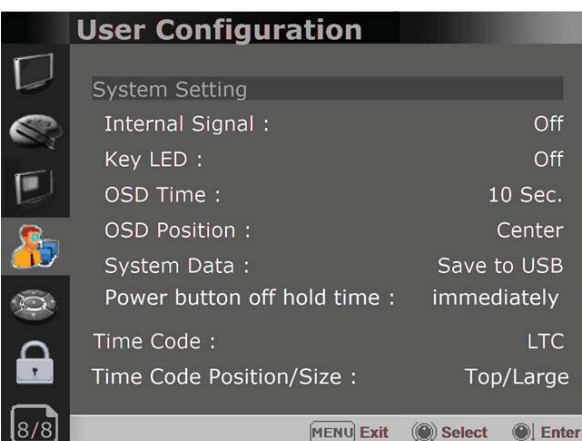

System Setting

Internal Signal

Generates the White and Color Bar internally. The selectable range is from 100%(White) to 0%(Black).

Key LED

Sets On to turn on the LED of the keys, and sets Off to turn off the LED of the keys.

OSD Time

Adjusts the display time of the OSD menu.

[10 Sec.]: The OSD menu will be disappeared after 10 seconds.

[20 Sec.]: The OSD menu will be disappeared about 20 seconds.

[30 Sec.]: The OSD menu will be disappeared about 30 seconds.

[On]: The OSD menu will not be disappeared.

OSD Position

Sets the position of OSD. Selects [Center] to [Left Bottom].

System Data

-[Save to USB]

Saves the current settings of the monitor to the USB memory.

-[Copy from USB]

Recalls the settings saved in the USB memory, and load them to the monitor.

- Saves and adjusts the settings of User 1 of User Preset.

Time Code

- Selects the type of the time code to be displayed.

[VITC]: To display the VITC time code

[LTC]: To display the LTC time code

Power button off hold time

-Set the action when pressing the front panel power button.

- [Immediately], [1 second], [2 seconds]

- [Immediately] : Power off immediately

[1 second] : Press and hold for 1 second to turn off the power

[2 seconds] : Press 2ch continuously to turn off the power

Time Code Position/Size

- Allows to adjust the size and position of the Time Code.



Remote Menu

Page 1/3

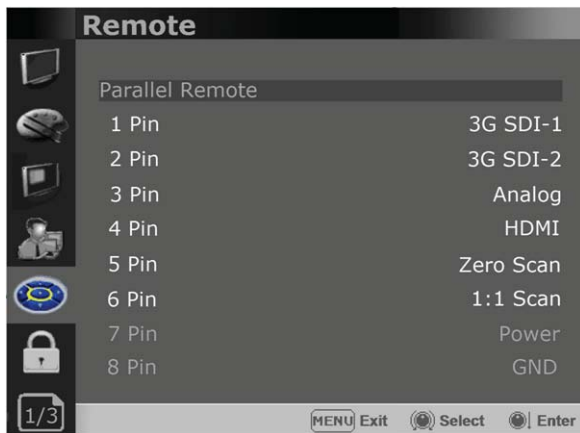

Parallel Remote

Selects the Parallel Remote connector pins for which you want to change the function. Various functions can be assigned to pin 1 to 6. The following is the list of the functions which can be assigned to the pins.

- [--]
- [3G SDI-1]
- [3G SDI-2]
- [Analog]
- [HDMI]
- [Zero Scan]
- [1:1 Scan]
- [4:3 Aspect]
- [16:9 Aspect]
- [Auto Aspect]
- [H/V Delay]
- [Blue Only]
- [Mono]
- [Marker]
- [TALLY R]
- [TALLY G]
- [User Preset1]
- [User Preset2]
- [User Preset3]
- [User Preset4]
- [User Preset5]
- [ITU-R BT.709]
- [Native]
- [OBM-HDR]
- [Cam. Log Default]
- [Cam. Log User]

- ** [--]: No function is assigned.
- *7 Pin: For Power On and Off only
- *8 Pin: For Ground only

Page 2/3



Monitor ID

Sets the ID of the monitor to control the monitor through Serial Remote or Network.

In-Monitor Display Setting

The monitor supports "TSL UMD Protocol – V3.1 & V5.0" provided by Television System Ltd. [Transparency], [Text Color], [Left Tally Color],

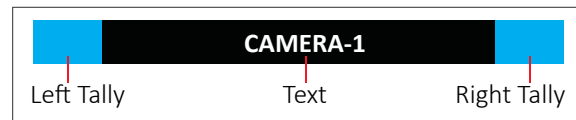

- ** The monitor displays English alphabet, numbers, Symbolic codes.
- ** Up to 16 characters can be displayed in English.

IMD Type

- Selects the In-Monitor Display type. Available modes are [Off],[TSL V3.1],[TSL V5.0].

Transparency

Selects [Full] or [Half] for the background of IMD.
 -[Full]: The background is black. The displayed image is hidden behind the background.
 -[Half]: The background is transparent. The displayed image can be seen indistinctly behind the IMD display.

Text Color

Selects the color of text displayed in IMD. -[White],[Red],[Green],[Blue],[Yellow],[Cyan],[Magenta] can be selected.

Left Tally Color

Selects the color of the left tally lamp displayed in IMD. -[White],[Red],[Green],[Blue],[Yellow],[Cyan],[Magenta] can be selected.

Right Tally Color

Selects the color of the right tally lamp displayed in IMD. -[White],[Red],[Green],[Blue],[Yellow],[Cyan],[Magenta] can be selected.



Remote Menu

Page 3/3



Network Setting

DHCP

- Toggle DHCP On or Off.
DHCP allows your monitor to receive an IP address from your network for remote control via various programs.

IP Address, Subnet Mask & Gateway

- You can manually configure network settings when DHCP is disabled.

Port No.

- Sets the port number.



Security Menu

Password Lock

- This function allows the user to protect the setting values through password.
- When the Password lock is applied, the functions and the setting values can be changed, but they are not saved.
- When you protect the setting values with a password, set a four-digit number.
- The initial password is 0000.
- When you use [Password], change the initial password first.

User Parameter Lock

Selects [On] to protect the setting values.
Selects [Off] to not protect by the password.
When [On] is selected, OSD background is displayed with the lock image as shown below.

** User Preset Lock is the function to protect the setting values of [User Preset1]. When User Preset Lock is On, the current setting values cannot be saved to [User Preset1], and the lock indicator appears in the menu [User Preset Setting]/[Save]/[User Preset1].

Change Password

Changes the password.



Security Menu



Security Setting

Key Lock

When Key Lock function is set On, the change of the menu settings and functions doesn't work.
** The same function as [Key Lock] button on the front panel.

7. Available Signal Formats

This monitor is applicable to the following signal formats

HD-SDI

Signal System	Signal Format
1920x1080 / 23.98, 24, 25, 29.97, 30p/Psf, 50, 59.94, 60i	4:2:2 YCbCr 10bit
2048 x 1080 / 23.98, 24, 25, 29.97, 30p/Psf	4:2:2 YCbCr 10bit
1280x 720 / 23.98, 24, 25, 29.97, 30, 50, 59.94, 60p	4:2:2 YCbCr 10bit

3G-SDI

Signal System	Signal Format	
1920 x1080 / 50, 59.94, 60p	4:2:2 YCbCr 10bit	Level A / Level B-DL
1920 x1080 / 23.98, 24, 25, 29.97, 30p/Psf, 50, 59.94, 60i	4:4:4 RGB 10bit 4:4:4 YCbCr 10bit 4:4:4 RGB 12bit 4:4:4 YCbCr 12bit	Level A / Level B-DL
1280x 720 / 23.98, 24, 25, 29.97, 30, 50, 59.94, 60p	4:4:4 RGB 10bit 4:4:4 YCbCr 10bit	Level A
2048 x1080 / 48, 50, 60p	4:2:2 YCbCr 10bit	Level A / Level B-DL
2048 x 1080 / 23.98, 24, 25, 29.97, 30p/Psf	4:4:4 RGB 10bit 4:4:4 YCbCr 10bit 4:4:4 RGB 12bit 4:4:4 YCbCr 12bit	Level A / Level B-DL

HDMI / DVI

Signal System	Signal Format
640 x 480p@59.94 / 60	4:4:4 RGB 8 / 10 / 12bit 4:4:4 YCbCr 8 / 10 / 12bit 4:2:2 YCbCr 12bit
720 x 480p@59.94 / 60	
720 x 576p@50	
1280 x 720p@50 / 59.94 / 60	
1920 x 1080i@50 / 59.94 / 60	
1920 x 1080p@23.98 / 24 / 25 / 29.97 / 30 / 50 / 59.94 / 60	
2048 x 1080p@23.98 / 24 / 25 / 29.97 / 30 / 47.95 / 48 / 50 / 59.94 / 60	
800 x 600p@60	4:4:4 RGB 8 / 10 / 12bit 4:4:4 YCbCr 8 / 10 / 12bit 4:2:2 YCbCr 12bit
1024 x 768p@60	

Analog Composite

Signal System	Signal Format
487/59.94i	NTSC
576/50i	PAL
487/59.94i	PAL-M
576/50i	SECAM

Analog Component

Signal System
720 x 480i/p@59.94/60
720 x 576i/p@50
1280 x 720p@50/59.95/60
1920 x 1080i@50/59.94/60
1920 x 1080p@23.98/24/25/29.97/30/50/59.94/60

8. Key Functions

High Dynamic Range(HDR) Display Function

The OBM N series provides the function to display the High Dynamic Range footage.

Postium HDR function allows users to view both highlights and shadow detail of scenes at the same time, thus resulting in more natural and realistic images.

The OBM N series supports PQ EOTF (SMPTE ST 2084), Hybrid Log Gamma and S-Log3.

HDR Mode

SDR Mode

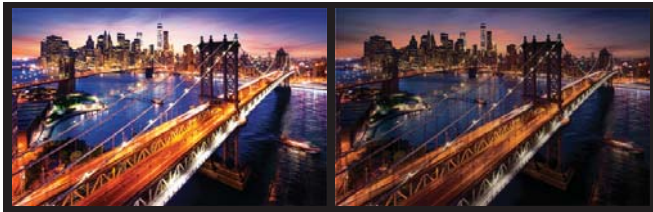

OBM-HDR provides the function of comparing HDR and SDR(Standard Dynamic Range) on the displayed image on the OBM series simultaneously.

HDR

SDR



Adjustable Gamma

Gamma value is adjustable from 1.0 to 3.0 as user's preference to monitor in the dark area of the picture.

Any pictures taken in either light or dark environment can be easily watched or analyzed.



Gamma 1.8



Gamma 2.4

Focus Assist

This function controls the aperture level of a video signal, and displays images on screen with sharpened edges to help camera focus operation.



Camera Log Mapped SDI Loopout

This function allows to load the camera log to the original image and then send the camera log mapped image to another monitor through SDI loop out.

[Monitor 1]

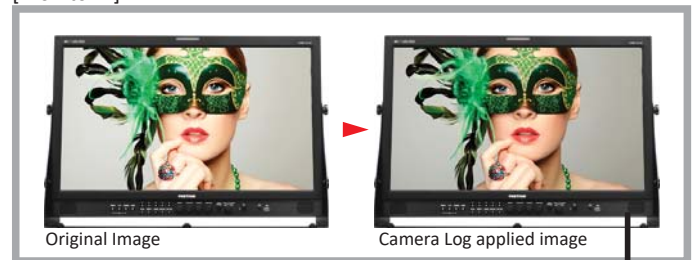

[Monitor 2]

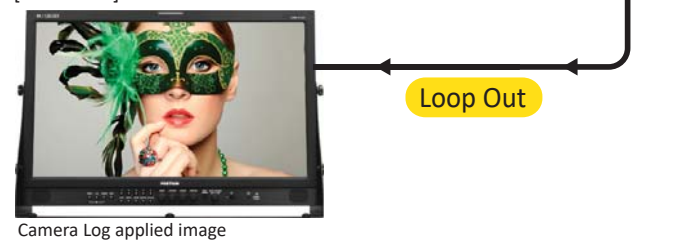

Remote Control via Ethernet

The OBM N series can be connected via Ethernet connection and controlled remotely on the network.



Black Stretch

The Black Stretch increases the visibility of subjects in dark areas, not degrading image quality in bright areas. This mode can be used to increase shadow detail without changing the absolute black level, and without affecting mid-tones.

Black Stretch Off



Black Stretch On



False Color

This function evaluates the Luma(Y') level of the input image. If the certain Y' level is set, the pixels with the designated Luma(Y') level are displayed with the zebra pattern or the color pattern. There are three modes in OBM False Color.

Zebra

This mode displays the Luma(Y') level of the input image in zebra pattern.



False Color ARRI

The color pattern is displayed with ARRI camera standard.



False Color Variable

This mode allows the user to adjust White clipping, Pink level, Green level, Black Clipping.



False Color Comparison

This function enables the user to divide the picture side by side, and compare the original image on the left half and the False Color image on the right half.



Password Lock for User Preset

When multiple users share the same monitor, each user can register his/her own password for color temperature and user preset data. This ensures the users correctly recalls their preset data, and keeps preset information safe from unauthorized use.

Gamut Error

Zebra pattern or Color is displayed on the portion whose Y, Cb, Cr and R, G, B are out of the range of the adjusted values based on the target color space which the user selects.

The default values of Y Maximum/Minimum, Chroma Maximum/Minimum, RGB Maximum/Minimum are in compliance with EBU R 103 standard. And, the values can be adjusted by the user.

** Default Values

YCbCr	Y Maximum : 984	RGB	Maximum : 984
	Y Minimum : 20		Minimum : 20
	Chroma Maximum : 1004		
	Chroma Minimum : 19		



Type 1: Black Zebra

When the targeted color space is selected as BT.709, the pixels outside of the targeted color space are displayed as Black Zebra. The pixels over Y Maximum, Chroma Maximum, RGB Maximum are displayed as Black Zebra, and the pixels below Y Minimum, Chroma Minimum, RGB Minimum are also displayed as Black Zebra.



Type 2: Black & White Zebra

When the targeted color space is selected as BT.709, the pixels outside of the targeted color space are displayed as Black or White Zebra. The pixels over Y Maximum, Chroma Maximum, RGB Maximum are displayed as Black Zebra, and the pixels below Y Minimum, Chroma Minimum, RGB Minimum are displayed as White Zebra.



Type 3: Mono

When the targeted color space is selected as BT.709, the pixels inside of the targeted color space are displayed as Mono, and the pixels outside of the targeted color space are displayed as the color. In this type, black and white area is not recognized.

Various Markers

The OBM N series can display various markers, including aspect marker, area marker, and center marker. In addition, the detailed display settings of each marker are allowed. For example, the color, brightness, horizontal/vertical position, and thickness of aspect markers can all be adjusted.



Display various markers

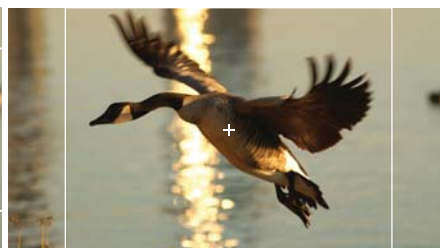

Aspect Mat 0

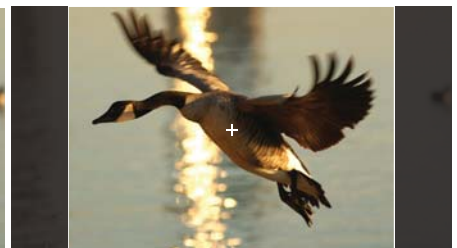

Aspect Mat 5

System Date Copy

This function allows users to save the monitor configuration and adjustment settings on the USB memory stick and load them to other monitors. This is useful for multiple monitor systems, allowing the transfer of one monitor's setup and adjustment data to another.

Camera Log Selection

The OBM series has the built-in camera LUT of the various camera manufacturers. It allows users to load the following camera logs.

Log-C, C-Log / S-Log2, S-Log3 / J-Log1

The more camera LUTs will be updated.

Waveform & Vector Scope Position Changeable

The position of Waveform and Vectro Scope can be changed among Left Top, Right Top, Right Bottom, Left Bottom.

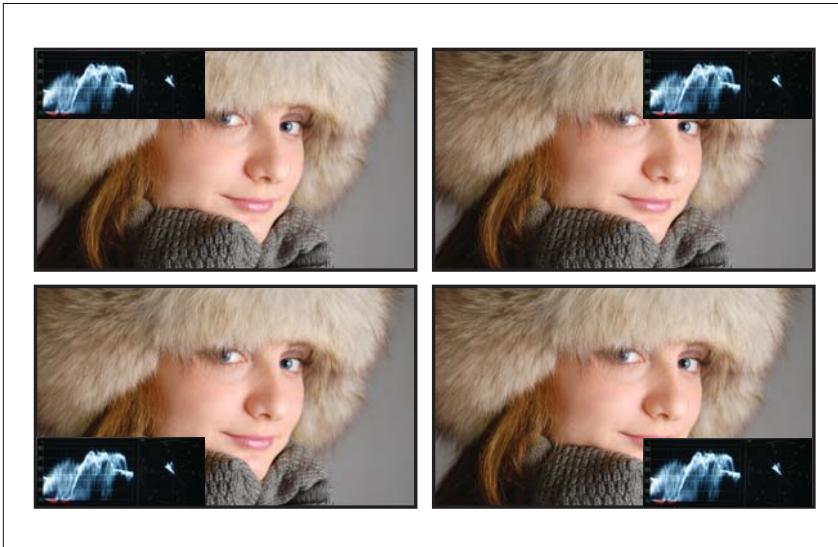

HDR Waveform

When HDR more is set on, HDR Waveform is displayed on screen.

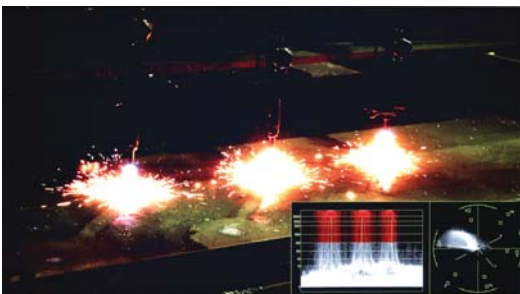

HDR Mode + HDR Waveform

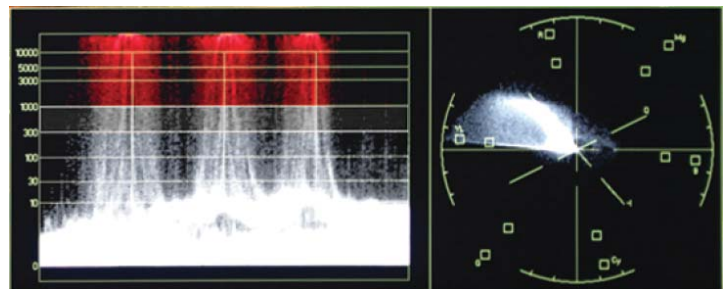

HDR Waveform

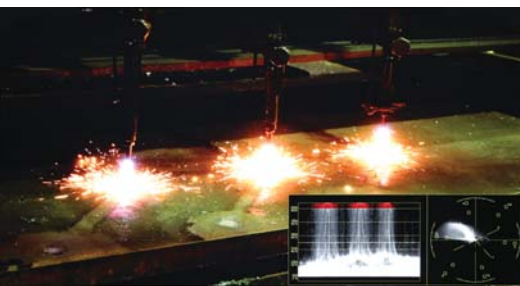

SDR Mode + SDR Waveform

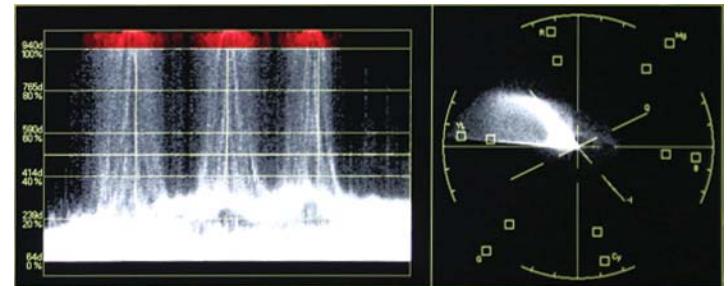

SDR Waveform

In-Monitor Display(IMD) Function

The image source names and tally information can be displayed on the screen, with an external remote function via Ethernet. The TSL system protocol is supported. The color of the source name and tally color can be selectable among White, Red, Green, Blue, Yellow, Cyan, Magenta.

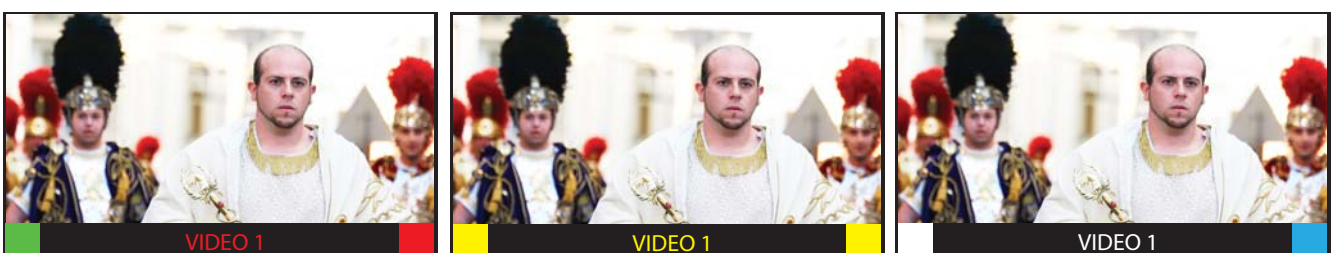

Custom 3D LUT File Import

The OBM series allow the user to import 3D Look-up Table for accurate and consistent color matching between individual displays. as well as using customized 'looks' that have been created by 3rd party color-grading applications. 32^{^3}, 33^{^3}, 64^{^3} and 65^{^3} cube file is supported.



9. Product Specifications

OBM-N170G / N180 / L180

ITEM		OBM-N170G	OBM-N180	OBM-L180	
Input	2 x BNC	3G/HD/SD-SDI-1/2		-	
	1 x HDMI	HDMI 1.3a		HDMI 1.3a	
	3 x BNC	Analog(YPbPr)		-	
	1 x BNC	Composite (CVBS)		3G/HD/SD-SDI	
	1 x DVI	DVI-D		-	
Output	2 x BNC	3G/HD/SD-SDI-1/2		3G/HD/SD-SDI	
Input Signal Format	SMPTE ST 425-AB	1080p(60/59.94/50/30/29.97/25/24/23.98/30sF/29.97sF/25sF/24sF/23.98sF) / 1080i (60/59.94/50)			
	SMPTE ST 274	1080p(30/29.97/25/24/23.98/24sF/23.98sF)			
		1080i (60/59.94/50)			
	SMPTE ST 296	720p(60/59.94/50)			
	SMPTE ST 260	1920 x 1035i(60/59.94)			
	SMPTE ST 2048	2048 x 1080p(24/23.98/24sF/23.98sF)			
	SMPTE ST 125	480i(59.94)			
	ITU-R BT.656	576i(50)			
	HDMI	~ 1080p(60)			
1 x DVI	VESA/IBM Modes		-		
Audio In/Out	1 x Phone Jack In	Line In(Stereo)			
	1 x Phone Jack Out	H/P Out(Front, Stereo)			
	2 x Speaker Out	Stereo		-	
Display	Size	16.5" LCD	18.5" LCD	18.5" LCD	
	Resolution	1920 x 1080 (16:9)	1920 x 1080 (16:9)	1920 x 1080 (16:9)	
	Pixel Pitch	0.1905mm	0.213mm	0.213mm	
	Color	1.073B colors(8bit+2bit FRC)	1.064B colors(8bit+2bit FRC)	1.064B colors(8bit+2bit FRC)	
	Viewing Angle	178(H), 178(V)	178(H), 178(V)	178(H), 178(V)	
	Luminance of White	450cd/m ²	350cd/m ²	350cd/m ²	
	Contrast	1500 : 1	1000 : 1	1000 : 1	
	Display Area (H x V)	365.8 x 205.7 (mm)	408.96 x 230.04 (mm)	408.96 x 230.04 (mm)	
General	1 x Ethernet	Control/Update, RJ-45P Input / Output		-	
	1 x GPIO	GPI-7 Port, RJ-45P Jack			
	2 x Serial	RS-422 Jack, RJ-45P Input / Output			
	1 x USB	For Firmware Update, Color Calibration			
	Power Requirements	AC(100-230V,50/60Hz)/DC12V		DC12V	
	Power Consumption	Max 40W	Max 40W	Max 40W	
	Operating Temperature	0 ~ 40°C(32°F~104°F)	0 ~ 40°C(32°F~104°F)	0 ~ 40°C(32°F~104°F)	
	Operating Humidity	20 ~ 80% RH	20 ~ 80% RH	20 ~ 80% RH	
	Weight	6.6kg/14.55lbs	6.5kg/14.33lbs	5.40kg/11.11lbs	
	Dimensions(with stand)	440 x 265 x 120mm		470 x 335 x 120mm	446 x 265.3 x 48.6mm
		17.32 x 10.43 x 4.72inch		18.50 x 13.18 x 4.72inch	12.25 x 10.90 x 1.91inch
	Accessories	Power Cable			
	Option	Rack Mount Kit / Carrying Case / Sun Hood / Acrylic Protector / V-Mount			

* Specifications are subject to change without prior notice for the product quality improvement.

OBM-N210 / N240

ITEM		OBM-N210	OBM-N240
Input	2 x BNC	3G/HD/SD-SDI-1/2	
	1 x HDMI	HDMI 1.3a	
	3 x BNC (YPbPr)	Analog(YPbPr)	
	1 x BNC (CVBS)	Composite	
	1 x DVI	DVI-D	
Output	2 x BNC	3G/HD/SD-SDI-1/2	
Input Signal Format	SMPTE ST 425-AB	1080p(60/59.94/50/30/29.97/25/24/23.98/30sF/29.97sF/25sF/24sF/23.98sF) / 1080i (60/59.94/50)	
	SMPTE ST 274	1080p(30/29.97/25/24/23.98/24sF/23.98sF)	
		1080i (60/59.94/50)	
	SMPTE ST 296	720p(60/59.94/50)	
	SMPTE ST 260	1920 x 1035i(60/59.94)	
	SMPTE ST 2048	2048 x 1080p(24/23.98/24sF/23.98sF)	
	SMPTE ST 125	480i(59.94)	
	ITU-R BT.656	576i(50)	
	HDMI	~ 1080p(60)	
1 x DVI	VESA/IBM Modes		
Audio In/Out	1 x Phone Jack In	Line In(Stereo)	
	1 x Phone Jack Out	H/P Out(Front, Stereo)	
	2 x Speaker Out	Stereo	
Display	Size	21.5" LCD	24" LCD
	Resolution	1920 x 1080 (16:9)	1920 x 1200 (16:10)
	Pixel Pitch	0.248mm	0.270mm
	Color	1.064B colors(8bit+2bit FRC)	1.064B colors(8bit+2bit FRC)
	Viewing Angle	178(H), 178(V)	178(H), 178(V)
	Luminance of White	400cd/m ²	300cd/m ²
	Contrast	1000 : 1	1000 : 1
	Display Area (H x V)	476.064 x 267.789 (mm)	518.4 x 324.0 (mm)
General	1 x Ethernet	Control/Update, RJ-45P Input / Output	
	1 x GPIO	GPI-7 Port, RJ-45P Jack	
	2 x Serial	RS-422 Jack, RJ-45P Input / Output	
	1 x USB	For Firmware Update, Color Calibration	
	Power Requirements	AC(100-230V,50/60Hz)/DC12V	
	Power Consumption	Max 40W	Max 40W
	Operating Temperature	0 ~ 40°C(32°F~104°F)	0 ~ 40°C(32°F~104°F)
	Operating Humidity	20 ~ 80% RH	20 ~ 80% RH
	Weight	8.5kg/18.73lbs	10kg/22.04lbs
	Dimensions(with stand)	538 x 363 x 120mm	
		21.18 x 14.26 x 4.72inch	
	Accessories	Power Cable	
	Option	Rack Mount Kit / Carrying Case / Sun Hood / Acrylic Protector / V-Mount	

* Specifications are subject to change without prior notice for the product quality improvement.

OBM-N310 / N420

ITEM		OBM-N310	OBM-N420	
Input	2 x BNC	3G/HD/SD-SDI-1/2		
	1 x HDMI	HDMI 1.3a		
	3 x BNC (YPbPr)	Analog(YPbPr)		
	1 x BNC (CVBS)	Composite		
	1 x DVI	DVI-D		
Output	2 x BNC	3G/HD/SD-SDI-1/2		
Input Signal Format	SMPTE ST 425-AB	1080p(60/59.94/50/30/29.97/25/24/23.98/30sF/29.97sF/25sF/24sF/23.98sF) / 1080i (60/59.94/50)		
	SMPTE ST 274	1080p(30/29.97/25/24/23.98/24sF/23.98sF)		
		1080i (60/59.94/50)		
	SMPTE ST 296	720p(60/59.94/50)		
	SMPTE ST 260	1920 x 1035i(60/59.94)		
	SMPTE ST 2048	2048 x 1080p(24/23.98/24sF/23.98sF)		
	SMPTE ST 125	480i(59.94)		
	ITU-R BT.656	576i(50)		
	HDMI	~ 1080p(60)		
1 x DVI	VESA/IBM Modes			
Audio In/Out	1 x Phone Jack In	Line In(Stereo)		
	1 x Phone Jack Out	H/P Out(Front, Stereo)		
	2 x Speaker Out	Stereo		
Display	Size	32" LCD	42" LCD	
	Resolution	1920 x 1080 (16:9)	1920 x 1080 (16:9)	
	Pixel Pitch	0.363mm	0.484mm	
	Color	1.064B colors(8bit+2bit FRC)	1.064B colors(8bit+2bit FRC)	
	Viewing Angle	178(H), 178(V)	178(H), 178(V)	
	Luminance of White	500cd/m ²	700cd/m ²	
	Contrast	3000 : 1	4000 : 1	
	Display Area (H x V)	698.4 x 392.85 (mm)	930.24 x 523.26 (mm)	
General	1 x Ethernet	Control/Update, RJ-45P Input / Output		
	1 x GPIO	GPI-7 Port, RJ-45P Jack		
	2 x Serial	RS-422 Jack, RJ-45P Input / Output		
	1 x USB	For Firmware Update, Color Calibration		
	Power Requirements	AC(100-230V,50/60Hz)/DC24V	AC(100-230V,50/60Hz)/DC24V	
	Power Consumption	Max 100W	Max 156W	
	Operating Temperature	0 ~ 40°C(32°F~104°F)	0 ~ 40°C(32°F~104°F)	
	Operating Humidity	20 ~ 80% RH	20 ~ 80% RH	
	Weight	28kg/61.72lbs	32kg/70.54lbs	
	Dimensions(with stand)	762 x 515 x 210mm	988x640x300mm	
		30 x 20.27 x 8.26inch	38.89 x 21.19 x 11.81inch	
	Accessories	Power Cable		
	Option	Wall Mount Kit / Carrying Case		

* Specifications are subject to change without prior notice for the product quality improvement.

OBM-N460 / N550

ITEM		OBM-N460	OBM-N550	
Input	2 x BNC	3G/HD/SD-SDI-1/2		
	1 x HDMI	HDMI 1.3a		
	3 x BNC (YPbPr)	Analog(YPbPr)		
	1 x BNC (CVBS)	Composite		
	1 x DVI	DVI-D		
Output	2 x BNC	3G/HD/SD-SDI-1/2		
Input Signal Format	SMPTE ST 425-AB	1080p(60/59.94/50/30/29.97/25/24/23.98/30sF/29.97sF/25sF/24sF/23.98sF) / 1080i (60/59.94/50)		
	SMPTE ST 274	1080p(30/29.97/25/24/23.98/24sF/23.98sF)		
		1080i (60/59.94/50)		
	SMPTE ST 296	720p(60/59.94/50)		
	SMPTE ST 260	1920 x 1035i(60/59.94)		
	SMPTE ST 2048	2048 x 1080p(24/23.98/24sF/23.98sF)		
	SMPTE ST 125	480i(59.94)		
	ITU-R BT.656	576i(50)		
	HDMI	~ 1080p(60)		
1 x DVI	VESA/IBM Modes			
Audio In/Out	1 x Phone Jack In	Line In(Stereo)		
	1 x Phone Jack Out	H/P Out(Front, Stereo)		
	2 x Speaker Out	Stereo		
Display	Size	46" LCD	54.6" LCD	
	Resolution	1920 x 1080 (16:9)	1920 x 1080 (16:9)	
	Pixel Pitch	0.530 mm	0.63mm	
	Color	1.064B colors(8bit+2bit FRC)	1.064B colors(8bit+2bit FRC)	
	Viewing Angle	178(H), 178(V)	178(H), 178(V)	
	Luminance of White	700cd/m ²	700cd/m ²	
	Contrast	4000 : 1	4000 : 1	
	Display Area (H x V)	1018.08 x 572.67 (mm)	1209.6 x 680.4 (mm)	
General	1 x Ethernet	Control/Update, RJ-45P Input / Output		
	1 x GPIO	GPI-7 Port, RJ-45P Jack		
	2 x Serial	RS-422 Jack, RJ-45P Input / Output		
	1 x USB	For Firmware Update, Color Calibration		
	Power Requirements	AC(100-240V, 50/60Hz)	AC(100-240V, 50/60Hz)	
	Power Consumption	220W	220W	
	Operating Temperature	0 ~ 40°C(32°F~104°F)	0 ~ 40°C(32°F~104°F)	
	Operating Humidity	20 ~ 80% RH	20 ~ 80% RH	
	Weight	35kg/77.16lbs	37kg/81.57lbs	
	Dimensions(with stand)	1074x687x300mm		1258 x 815 x 270mm
		42.28 x 27.04 x 11.81inch		49.52 x 32.08 x 10.62inch
	Accessories	Power Cable		
	Option	Wall Mount Kit / Carrying Case		

* Specifications are subject to change without prior notice for the product quality improvement.

OBM-R210

ITEM		OBM-R210
Input	BNC (SDI)	2 x 3G/HD/SD-SDI-1/2
	HDMI	1 x HDMI 1.3a
	BNC (YPbPr)	3 x Analog(YPbPr)
	BNC (CVBS)	1 x Composite
	DVI	1 x DVI-D
Output	BNC (SDI)	2 x 3G/HD/SD-SDI-1/2
Input Signal Format	SMPTE ST 425-AB	1080p(60/59.94/50/30/29.97/25/24/23.98/30sF 29.97sF/25sF/24sF/23.98sF) / 1080i (60/59.94/50)
	SMPTE ST 274	1080p(30/29.97/25/24/23.98/24sF/23.98sF)
		1080i (60/59.94/50)
	SMPTE ST 296	720p(60/59.94/50)
	SMPTE ST 260	1920 x 1035i(60/59.94)
	SMPTE ST 2048	2048 x 1080p(24/23.98/24sF/23.98sF)
	SMPTE ST 125	480i(59.94)
	ITU-R BT.656	576i(50)
	HDMI	1080p(60)
DVI-D	VESA/IBM Modes	
Audio In/Out	1 x Phone Jack In	Line In(Stereo)
	1 x Phone Jack Out	H/P Out(Front, Stereo)
	2 x Speaker Out	Stereo
Display	Size	21" LCD
	Resolution	1920 x 1080 (16:9)
	Pixel Pitch	0.270mm
	Color	True 16.7M Colors
	Viewing Angle	178(H), 178(V)
	Luminance of White	2000cd/m ²
	Contrast	1000 : 1
	Active Area (H x V)	476.064 (H)mm x 267.786 (V) mm
General	1 x Ethernet	Control/Update, RJ-45 Input
	1 x GPIO	GPI-7 Port, RJ-45P Jack
	2 x Serial	RS-422 Jack, RJ-45P Input / Output
	1 x USB	For Firmware Update, Color Calibration
	Power Requirements	AC(100-230V,50/60Hz) / DC24V
	Power Consumption	Max 40W
	Operating Temperature	0 ~ 40°C(32°F~104°F)
	Operating Humidity	20 ~ 80% RH
	Weight	TBD
	Dimensions	505 x 297 x 55 mm / 19.88 x 11.69 x 2.16 inch
	Accessories	Power Cable / Rack Mount Kit
	Option	VESA Mount / Wall Brack

* Specifications are subject to change without prior notice for the product quality improvement.

OBM-H210

ITEM		OBM-H210
Input	BNC (SDI)	2 x 3G/HD/SD-SDI-1/2
	HDMI	1 x HDMI 1.3a
	BNC (YPbPr)	3 x Analog(YPbPr)
	BNC (CVBS)	1 x Composite
	DVI	1 x DVI-D
Output	BNC (SDI)	2 x 3G/HD/SD-SDI-1/2
Input Signal Format	SMPTE ST 425-AB	1080p(60/59.94/50/30/29.97/25/24/23.98/30sF 29.97sF/25sF/24sF/23.98sF) / 1080i (60/59.94/50)
	SMPTE ST 274	1080p(30/29.97/25/24/23.98/24sF/23.98sF)
		1080i (60/59.94/50)
	SMPTE ST 296	720p(60/59.94/50)
	SMPTE ST 260	1920 x 1035i(60/59.94)
	SMPTE ST 2048	2048 x 1080p(24/23.98/24sF/23.98sF)
	SMPTE ST 125	480i(59.94)
	ITU-R BT.656	576i(50)
	HDMI	1080p(60)
DVI-D	VESA/IBM Modes	
Audio In/Out	1 x Phone Jack In	Line In(Stereo)
	1 x Phone Jack Out	H/P Out(Front, Stereo)
	2 x Speaker Out	Stereo
Display	Size	21" LCD
	Resolution	1920 x 1080 (16:9)
	Pixel Pitch	0.270mm
	Color	True 16.7M Colors
	Viewing Angle	178(H), 178(V)
	Luminance of White	1500cd/m ²
	Contrast	1000 : 1
	Active Area (H x V)	476.064 (H)mm x 267.786 (V) mm
General	1 x Ethernet	Control/Update, RJ-45 Input
	1 x GPIO	GPI-7 Port, RJ-45P Jack
	2 x Serial	RS-422 Jack, RJ-45P Input / Output
	1 x USB	For Frmware Update, Color Calibration
	Power Requirements	AC(100-230V,50/60Hz) / DC24V
	Power Consumption	Max 40W
	Operating Temperature	0 ~ 40°C(32°F~104°F)
	Operating Humidity	20 ~ 80% RH
	Weight	8.5kg/18.73lbs
	Dimensions	552 x 364.8 x 127mm / 21.73 x 14.36 x 5inch
	Accessories	Power Cable
	Option	VESA Mount / Rack Mount Kit / Hard Case

* Specifications are subject to change without prior notice for the product quality improvement.



POSTIUM KOREA Co., Ltd.

208, Building A, Samsung Techno Valley, 140, Tongil-ro,
Deogyang-gu, Goyang-si, Gyeonggi-do, Korea, 10594

Tel : +82.2.354.6055 / Fax : +82.2.354.6056

E-mail : sales@postium.com

www.postium.com