

**4K
Quad**

OBM-4K Q SERIES

18.4" 24" 32" 42.5"

4K Quad-Split Monitor

4 x 12G-SDI Input

4 x 12G-SDI Output

1 x HDMI 2.0

1.064 Billion Colors

Panel Resolution 3840 x2160

Native 33x33x33 30bit 3D-LUT

Each Waveform/Vector Scope, UMD, Time Code Display

3G-SDI Level A/B Support

3D LUT Accurate Color Reproduction

HDR Support



The OBM-4K Q series receives and displays four 4K signals simultaneously. It provides the ability to display HDR (High Dynamic Range) images and supports a wide color gamut compatible with DCI-P3.

The OBM-4K Q series delivers professional performance including excellent black quality and accurate color reproduction, making this monitor ideal for 4K live production, a variety of monitoring and field production applications.

The OBM-4K Q series also supports integrated 3D LUT, Waveform, Vector Scope and a full feature set. The series is available in 18.4", 24", 32" and 42.5".



POSTIUM KOREA Co., Ltd.
www.postium.com

Product Highlights

- Video Input: 4 x 12G-SDI Output: 4 x 12G-SDI
- 1 x HDMI 2.0
- Audio In: Embedded Audio, Analog Stereo (Phone Jack)
- Audio Out: Analog Stereo (Phone Jack), Internal Speaker(Mono/Stereo)
- 3G-SDI Level A/B Support
- 3D LUT Accurate Color Reproduction
- HDR Support
- Waveform/Vector Scope
- Various Display Modes
- Adjustable Gamma
- Time Code Display
- Audio Level Meter Display
- UMD
- 1:1 Pixel Mapping
- Blue Only
- H/V Delay
- Various Markers
- Blue/Mono Only
- Various Scan modes
- Freeze Frame
- 3 Color Tally Lamp
- Remote Control via GPI(RJ-45) Port
- Firmware Update via USB Flash Memory
- Rack & VESA Mount(Optional)
- Color Temperature (3200K, 5500K, 6500K, 9300K, USER 1/2/3, D-CINEMA)
- Color Space
- Gamma Selection (1.0 ~ 3.0)
- Zero Scan
- Aspect(only 16:9)

Parts and Controls

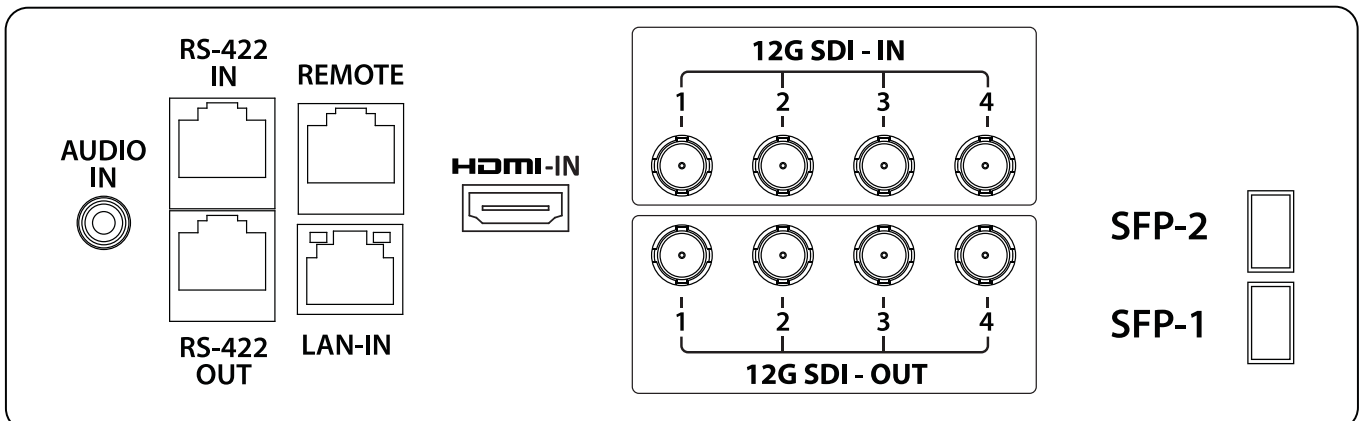

Specifications

ITEM		OBM-U180Q	OBM-U240Q	OBM-U310Q	OBM-U420Q
Input	4 x BNC	12G/6G/3G/HD			
	1 x HDMI	HDMI® 2.0			
	2 x SFP	SFP			
Output	4 x BNC	12G/6G/3G/HD 4 Active Loop Output			
Input Signal Format	SMPTE ST 2082-12(12G Quad 8K)	4320p(60/59.94/50)			
	SMPTE ST 2082-10(12G Single)	2160p(60/59.94/50/30/29.97/25/24/23.98)			
	SMPTE ST 2081-11(6G Dual)	2160p(60/59.94/50)			
	SMPTE ST 2081-10(6G Single)	2160p(30/29.97/25/24/23.98)			
	SMPTE ST 425-AB	1080p(60/59.94/50/30/29.97/25/24/23.98/30sF/29.97sF/25sF/24sF/23.98sF) / 1080i (60/59.94/50)			
	SMPTE ST 274	1080p(30/29.97/25/24/23.98/24sF/23.98sF)			
		1080i (60/59.94/50)			
	SMPTE ST 296	720p(60/59.94/50)			
	SMPTE ST 260	1920 x 1035i(60/59.94)			
	SMPTE ST 2048	2048 x 1080p(24/23.98/24sF/23.98sF)			
	HDMI 2.0	~ 2160p(60)			
SFP	12Gbps, 6Gbps, 2.970Gbps, 1.485Gbps				
Audio	1 x Phone Jack In	Line In(Stereo)			
	1 x Phone Jack Out	H/P Out(Front, Stereo)			
	2 x Speaker Out	Stereo(420Q has no speakers)			
Display	Size	18.4" LCD	23.74" LCD	32" LCD	42.51" LCD
	Resolution	3840 x 2160 (16:9)	3840 x 2160 (16:9)	3840 x 2160 (16:9)	3840 x 2160 (16:9)
	Pixel Pitch	408.96 x 230.04 mm	0.1369mm	0.1845mm	0.2451mm
	Color	1.07G(8Bit+FRC)	1.073B Colors, 10Bit	1.073B Colors, 10Bit	1.073B Colors, 10Bit
	Viewing Angle	170(H), 170(V)	178(H), 178(V)	178(H), 178(V)	178(H), 178(V)
	Luminance of White	1000 cd/m ²	540cd/m ² (HDR Maximum 400cd/m ²)	1000cd/m ² (HDR Maximum 700cd/m ²)	700cd/m ² (HDR Maximum 400cd/m ²)
	Contrast	1,000 : 1	1200 : 1	1500 : 1	1000 : 1
	Display Area (H x V)	0.03555 x 0.1065	525.65 x 295.70 (mm)	708.48 x 398.52 (mm)	941.184 x 529.416 (mm)
	General	2 x Ethernet	Control/Update, RJ-45P Input / Output		
1 x GPIO		GPI-7 Port, RJ-45P Jack			
2 x Serial		RS-422 Jack, RJ-45P Input / Output			
1 x USB		For Firmware Update, Color Calibration			
Power Requirements		AC(100-230V, 50/60Hz)/DC 24V	AC(100-230V, 50/60Hz)/DC 24V	AC(100-230V, 50/60Hz)/DC 24V	AC(100-230V, 50/60Hz)
Power Consumption		75W	80W	120W	150W
Operating Temperature		0°C ~ 40°C(32°F~104°F)	0°C ~ 40°C(32°F~104°F)	0°C ~ 40°C(32°F~104°F)	0°C ~ 40°C(32°F~104°F)
Operating Humidity		20% ~ 80% RH	20% ~ 80% RH	20% ~ 80% RH	20% ~ 80% RH
Weight (with stand)		7.7kg / 16.97lbs	10.5kg / 23.14lbs	14.8kg / 32.62lbs	34kg / 74.95lbs
Dimensions		471 x 335 x 120mm	605 x 400 x 140mm	762 x 513 x 190 mm	990 x 639 x 210 mm
(with stand)		18.54 x 13.18 x 4.72inch	23.81 x 15.74 x 5.51inch	30 x 20.15 x 7.48 inch	38.97 x 25.15 x 8.26 inch
Accessories		Power Cable			
Option		Wall Mount Kit/ Carrying Case			

* Specifications are subject to change without prior notice for the product quality improvement.

Dimensions(mm)

OBM-U180Q

Main Body : 436 x 310 x 81 mm / 17.16 x 12.20 x 3.18 inch --With Stand : 445 x 329 x 120 mm / 17.51 x 12.20 x 4.72 inch

Weight : Main Body : 6.6kg / 14.55lbs --With Stand : 7.8kg / 17.19lbs

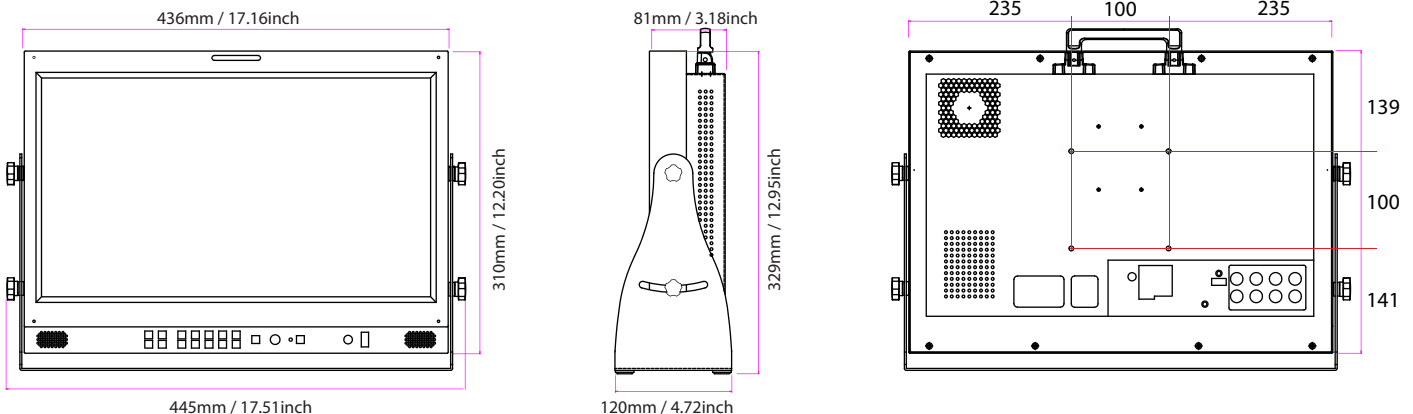

OBM-U240Q

Main Body : 570 x 380 x 83 mm / 22.44 x 12.12 x 3.26 inch --With Stand : 605 x 400 x 140 mm / 23.81 x 15.74 x 5.51 inch
 Weight : Main Body : 9.3kg / 20.50lbs ---With Stand : 10.9kg / 24.03lbs

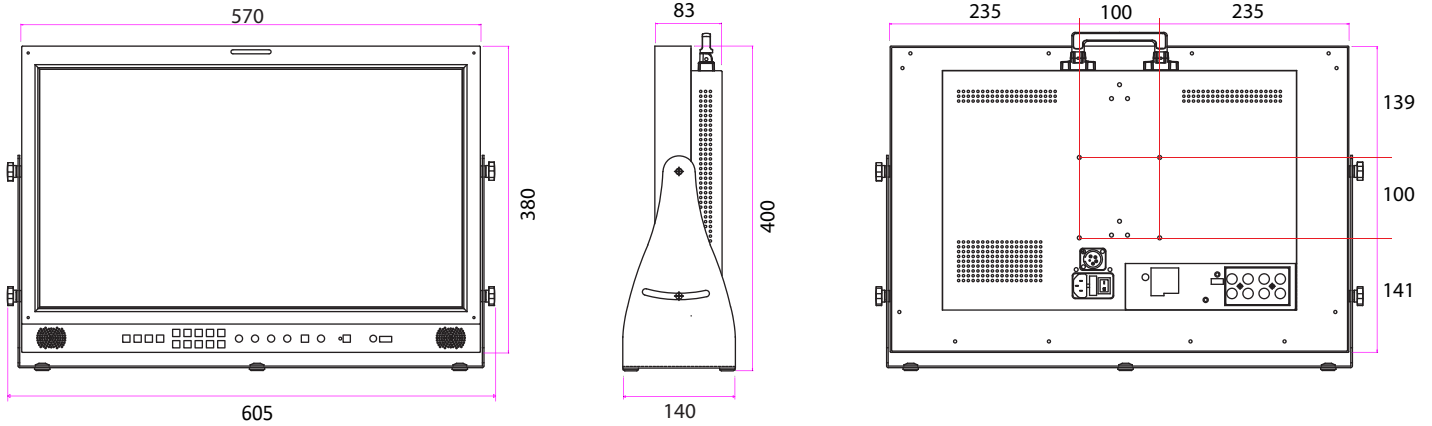

OBM-U310Q

Main Body : 762 x 482.2 x 80 mm / 30 x 18.99 x 3.14 inch --With stand : 762 x 512 x 190mm / 30 x 20.15 x 7.48inch
 Weight -- Main Body : 13.1kg / 28.88lbs --With Stand : 14.8kg / 32.62lbs

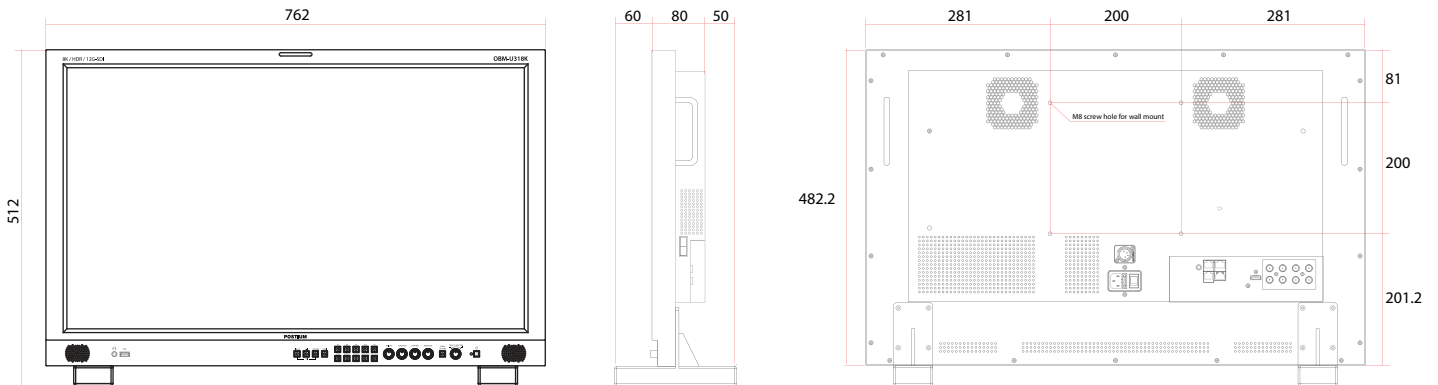

OBM-U420Q

Main Body : 990 x 609 x 86.5 mm / 38.97 x 23.97 x 3.4 inch --With stand : 990 x 639.70 x 210mm / 38.97 x 25.18 x 8.26inch
 Weight --Main Body : 32kg / 70.54lbs. --With Stand : 34kg / 74.95lbs

